



2501 Ludelle Street
Fort Worth, Texas 76105
817-244-6212 Phone • 817-244-4024 Fax
888-350-6588 Sales • 800-423-9696 Tech
E-mail: support@painlessperformance.com
Web: www.painlessperformance.com

60110

200-4R TRANSMISSION LOCK-UP HARNESS INSTALLATION INSTRUCTIONS

Your engine must produce at least 5 in.HG vacuum for this kit to work properly.

INSTALLATION INSTRUCTIONS (TRANSMISSION)

1. Remove the transmission oil pan bolts, carefully drain the transmission fluid and remove the pan.
2. Next, remove the transmission fluid filter by gently twisting and pulling down on the filter. Note: The filter neck rubber seal will more than likely stay inside the pump housing and will only need to be removed if the filter is to be replaced.
3. Now, remove the two 10mm torque converter clutch solenoid bolts and pull the solenoid and attached original harness. Use caution not to break the retaining tab when removing the case connector plug.
4. Locate and remove the 4th gear pressure switch from the valve body housing and install the new 4th gear switch. See Figures 1 & 2.



Figure 1

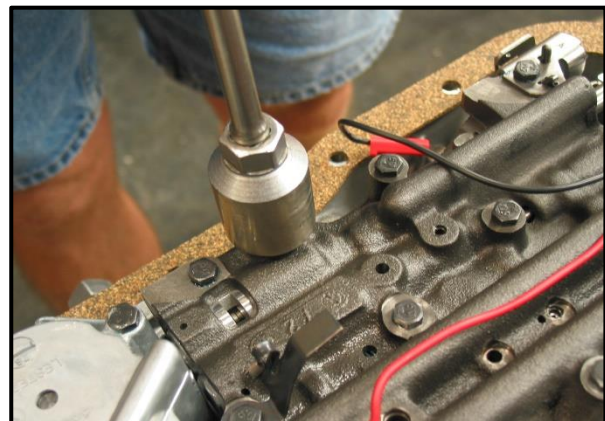

Figure 2

5. Next, install the new torque converter clutch solenoid using the new studs and the included shouldered nuts. Torque both the studs into the case and the nuts to the solenoid at **95 in/lbs** (about 8 ft/lbs). See Figures 3, 4, & 5.



Figure 3

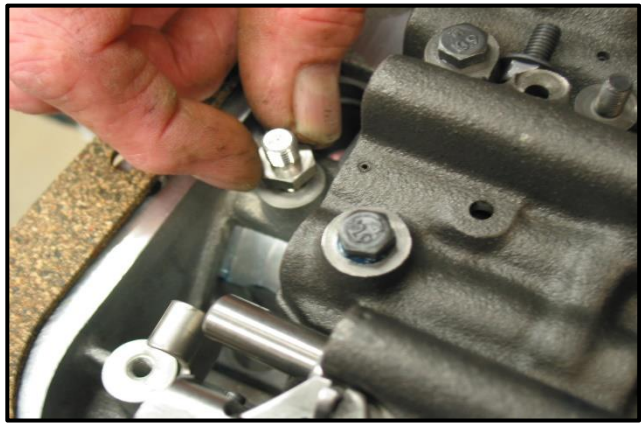

Figure 4



Figure 5

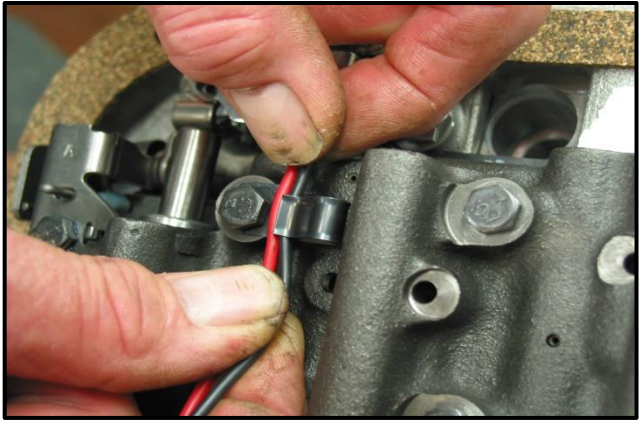

Figure 6

6. Carefully fasten the wires using the original metal clips on the valve body bolts. See **Figures 6 and 7**. Attach the red connector to the new 4th gear pressure switch. See **Figure 8**.

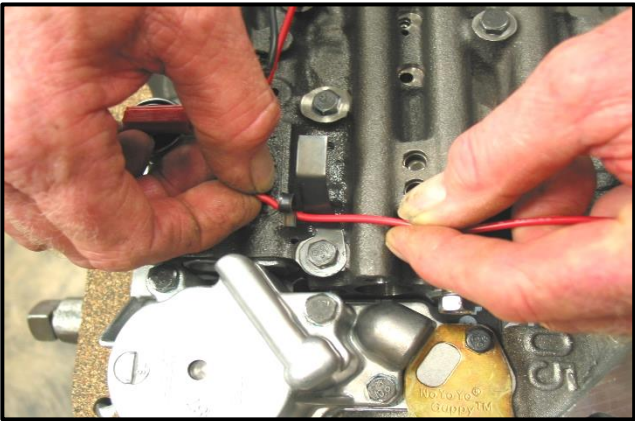

Figure 7



Figure 8

7. Install the new transmission case connector provided in this kit. Attach the single red wire w/ the black, 4-way connector to the transmission case connector.
8. Plug in the black, 4-way connector into the case connector. See **Figure 9 & 10**.

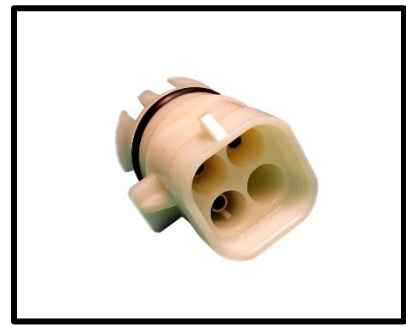

Figure 9



Figure 10

9. With the harness installed properly, it should be routed as shown in **Figure 11**.

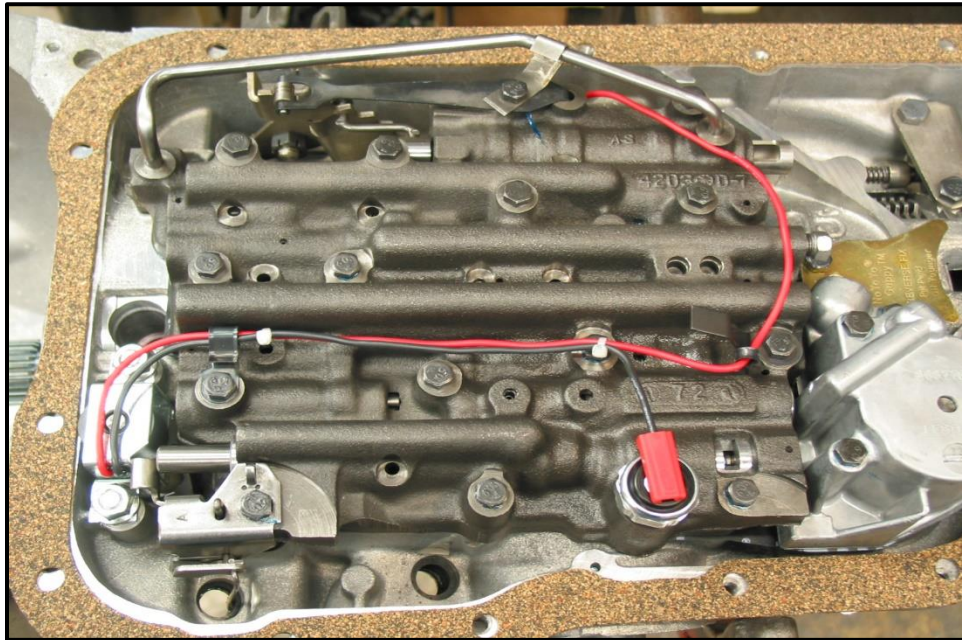
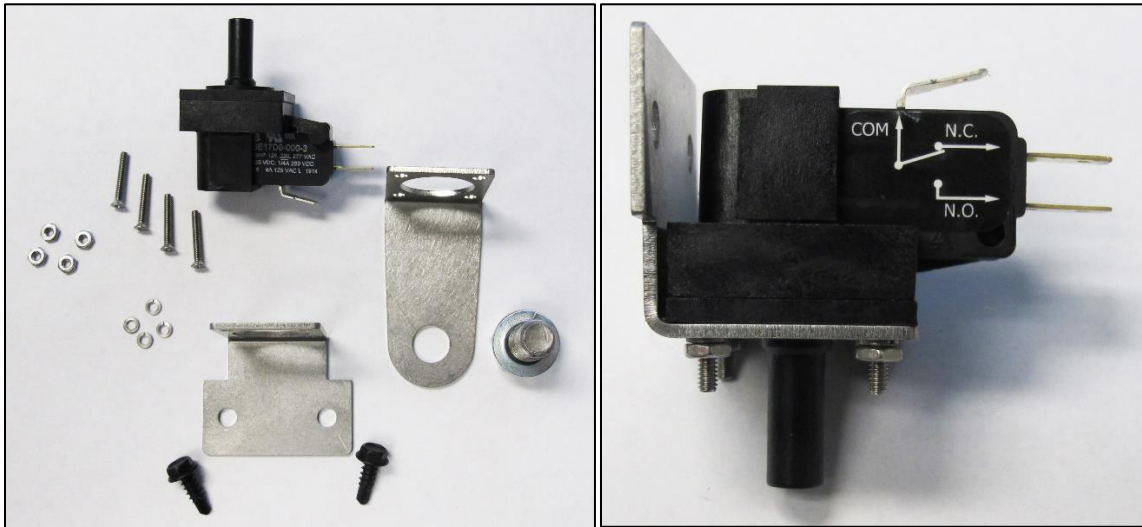

Figure 11

10. Reinstall the transmission filter and pan with the new gasket provided.
11. Fill transmission with the correct amount and type of transmission fluid. 200-4R transmissions require at least Dextron III fluid.

INSTALLATION INSTRUCTIONS



- A. Mount the vacuum switch to one of the supplied brackets, this will require a small philips head screw driver and a 3/16" socket or nut driver. Painless recommends mounting this over a work bench or table as the mounting hardware for the switch is very small and can be easy lost if dropped. The mounting bolt in meant to go through the switch and then through the bracket. The position of the switch on the bracket will be up to the installers preferred orientation.

The longer bracket and supplied bolt will allow mounting the switch to the back of a head or to a 3/8" hole on the intake manifold. The other bracket will allow the switch to be mounted to the firewall using the supplied self-tapping screws.

- B. Mount the vacuum switch in the engine compartment. Connect a 1/4" vacuum hose to the vacuum switch and then connect the hose to a **ported** manifold vacuum source. Ported manifold vacuum will come from in front of the throttle blade(s) and will only have vacuum when the throttle is opened.

- C. Move to the inside of the vehicle and install the provided brake switch at the brake pedal.

NOTE: If you are using a button style switch with 2 terminals the supplied switch will replace it.

If you have a double switch, like the one provided, already installed for cruise control, then the purple wire of the supplied brake switch connector will be cut from the connector and spliced to the cruise control output wire of your existing brake switch wiring. This will be the wire that loses power when the brake is applied.

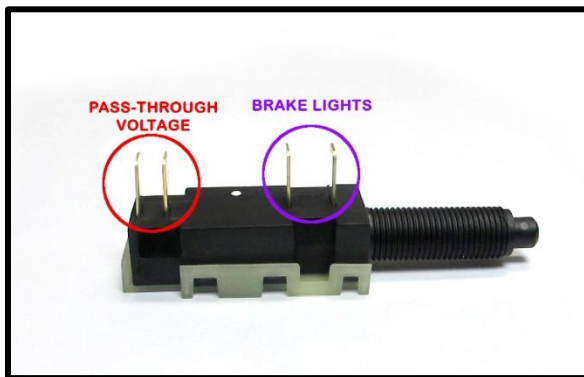

If you are using a hydraulic pressure switch, a bracket will be needed to mount the switch so when the pedal is up the switch is fully depressed or a relay will need to be installed. If the relay is wired as shown, the purple wire will receive power from pin 30 via 87a. As soon as the brake is applied, power will be sent to pin 86, this will activate the relay, opening the connection between pins 30 and 87a.

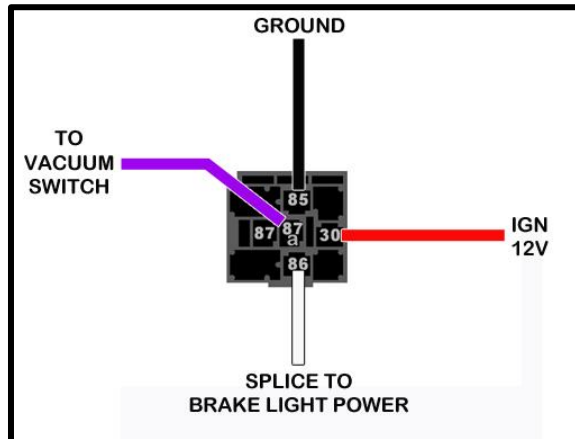

- D. Route the red wire from the brake switch to a (20 amp) fused ignition power source. This power source needs to only have power when the key is in the “on/run” position.
- E. Route the purple wire from the brake switch out into the engine compartment to the vacuum switch. Cut the wire to length, strip ¼” of insulation, and install one of the supplied insulated terminals. Connect this terminal to either the “COM” (common) or “N.O.” (normally open) tab; it doesn’t matter which one.

F. Route the purple wire with the white 4-way connector down to the transmission and plug into the factory plug located above the pan on the driver’s side of the case.

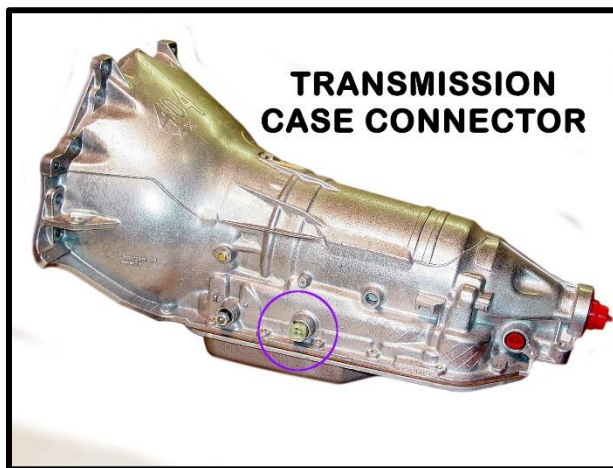

G. Route the purple wire from the transmission to the vacuum switch. Cut the wire to length, strip ¼” of insulation, and install one of the supplied insulated terminals. Connect this terminal to either the “COM” (common) or “N.O.” (normally open) tabs; whichever one you did not connect to previously.

- H. Test drive the vehicle. The transmission should shift into overdrive and lock the converter at about 40-45 m.p.h. the gear ratio of your differential will determine lock up speed. If the converter locks up early, check to make sure you are connected to ported manifold vacuum, as explained in step B.
- I. If you encounter a constant lock-unlock situation in city traffic a vacuum valve (BWD part #EC605 or Standard part # DCV2) may be installed in the vacuum switch hose to correct the problem. This valve must be placed with the black end of the valve towards the vacuum switch.

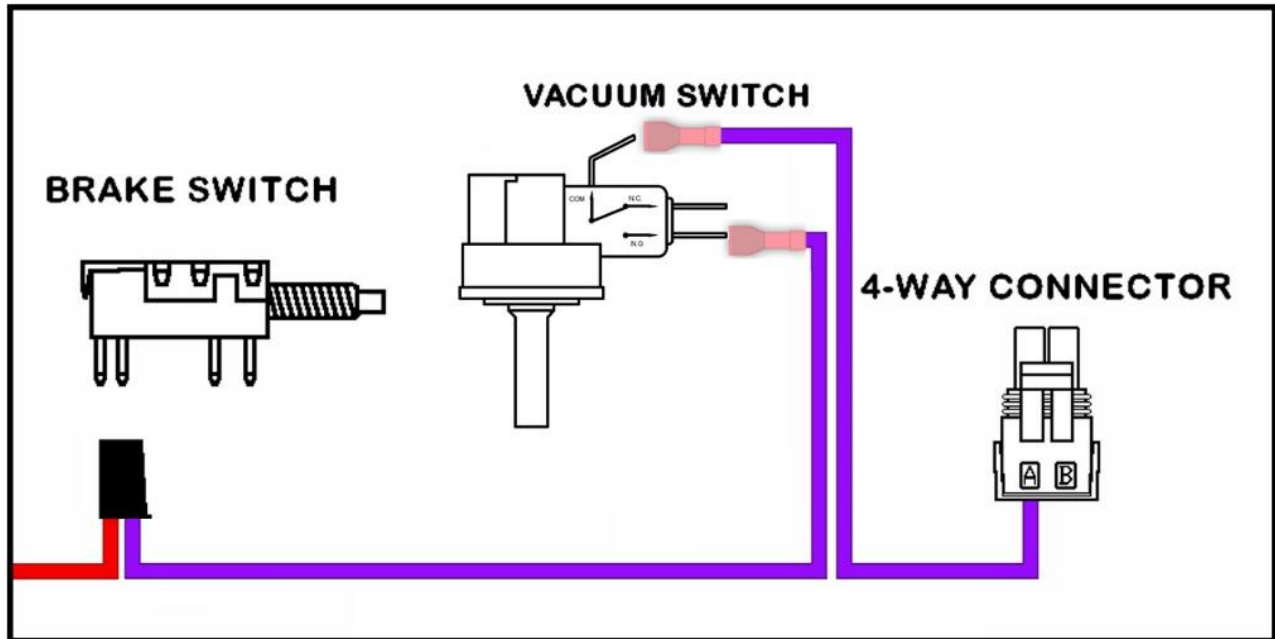

**Painless Performance Limited Warranty
and Return Policy**

Chassis harnesses and fuel injection harnesses are covered under a lifetime warranty.

All other products manufactured and/or sold by Painless Performance are warranted to the original purchaser to be free from defects in material and workmanship under normal use. Painless Performance will repair or replace defective products without charge during the first 12 months from the purchase date. No products will be considered for warranty without a copy of the purchase receipt showing the sellers name, address, and date of purchase. You must return the product to the dealer you purchased it from to initiate warranty procedures.

Copyright © 2020 by Perfect Performance Products, LLC