

# Neutron Lifecycle Series: Helium-3 Gas Detectors at the SNS and HFIR

July 21, 2016

Kevin Berry



# At SNS, ~ 2/3 of the operating instruments that the Detector Group supports use <sup>3</sup>He detectors

## Spallation Neutron Source at Oak Ridge National Laboratory

The world's most intense pulsed, accelerator-based neutron source

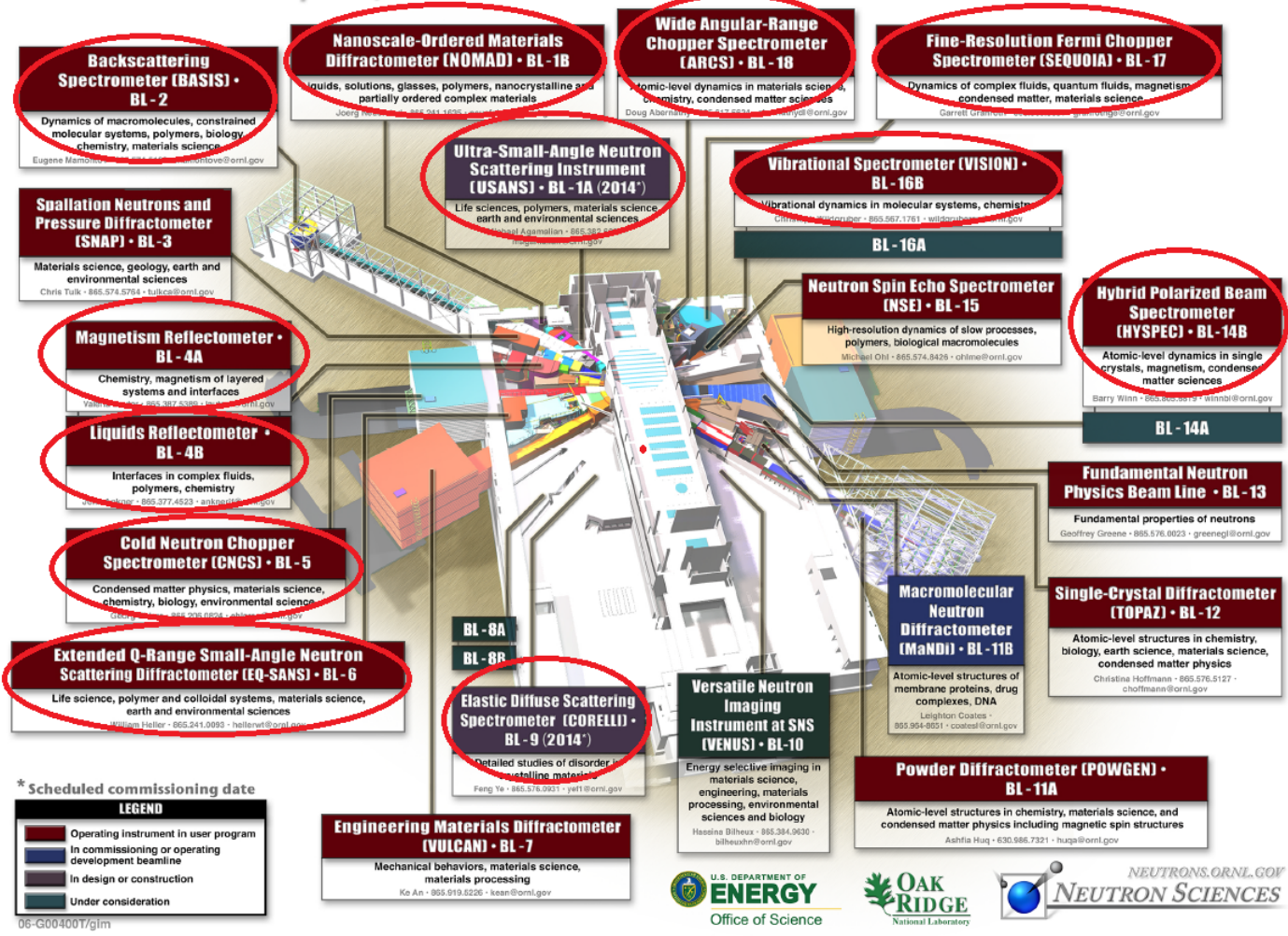

# ... as well as most of the instruments at HFIR

## High Flux Isotope Reactor at Oak Ridge National Laboratory



The United States' highest flux reactor-based neutron source

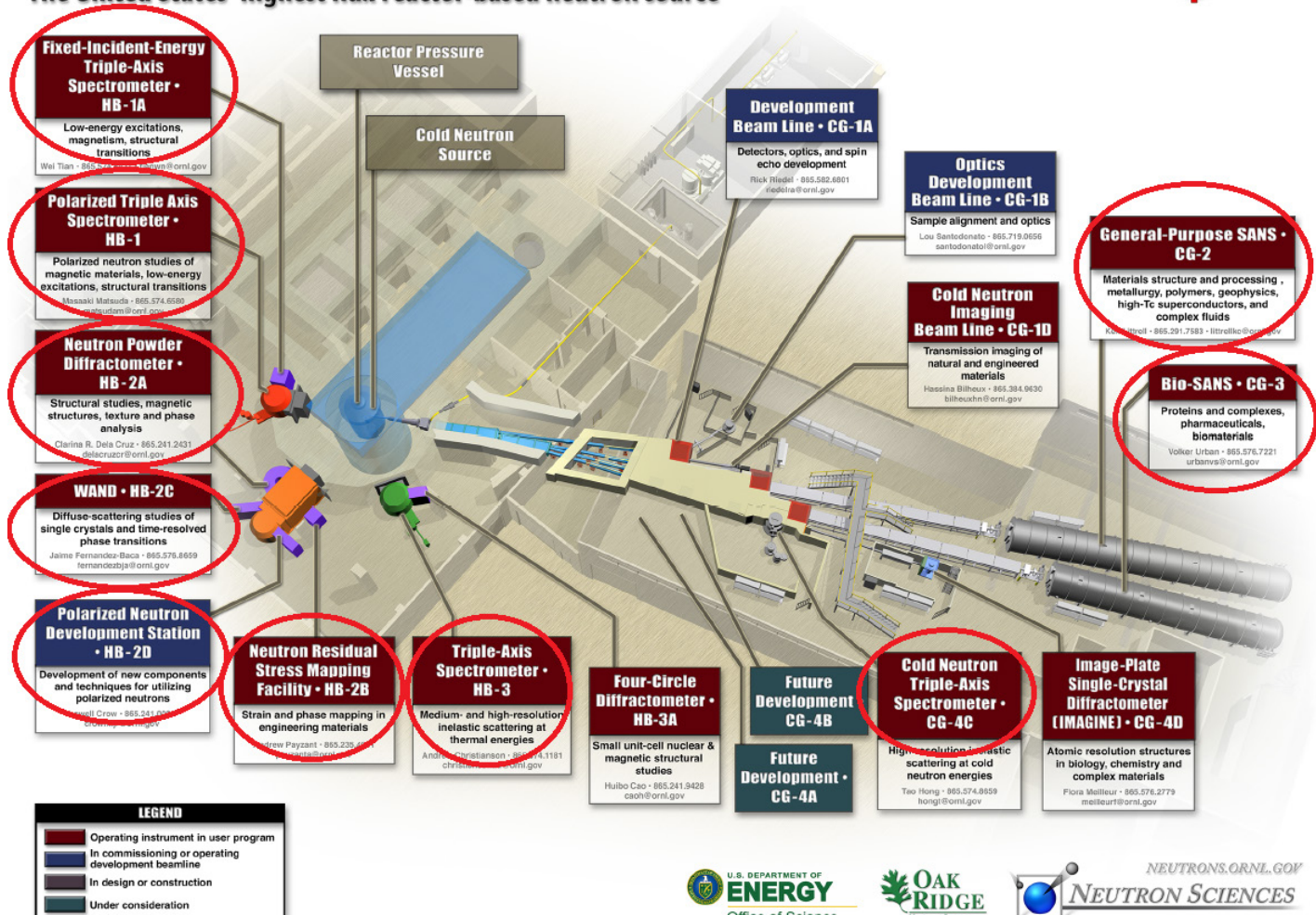

07-G00244N/gjm



# Single output tubes – used individually or arranged into 1d array

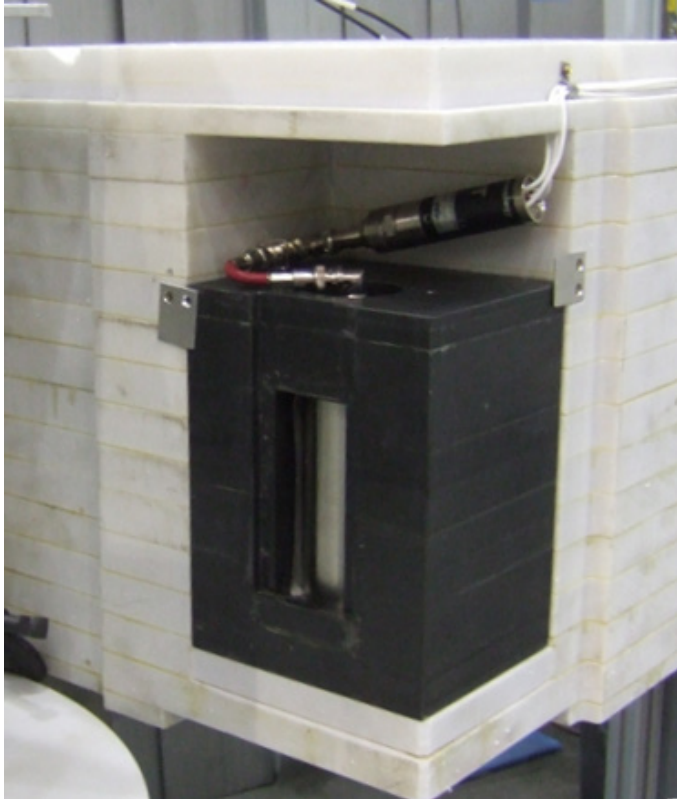

**Linear Position Sensitive Detectors (LPSDs)**  
**vacuum compatible, typical installations cover**  
**large areas (10s of m<sup>2</sup>)**  
**(GE Reuter-Stokes)**

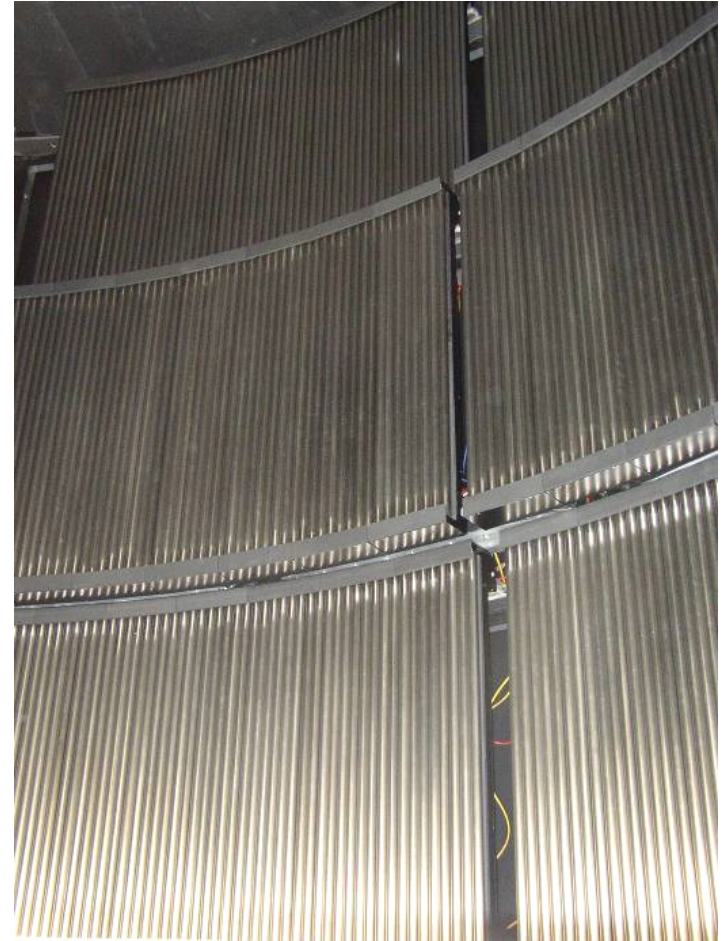
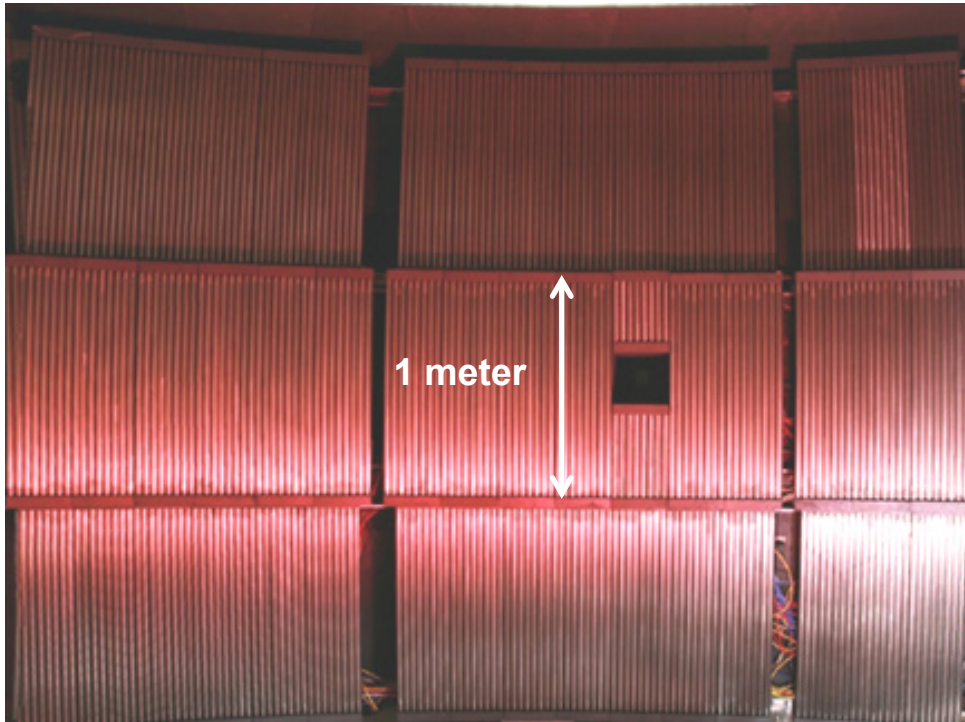

# Wide variety of configurations – linear, radial, or curved about horizontal or vertical axis

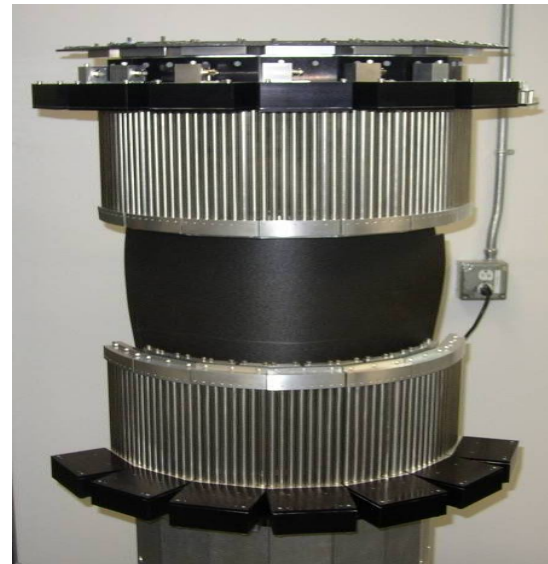
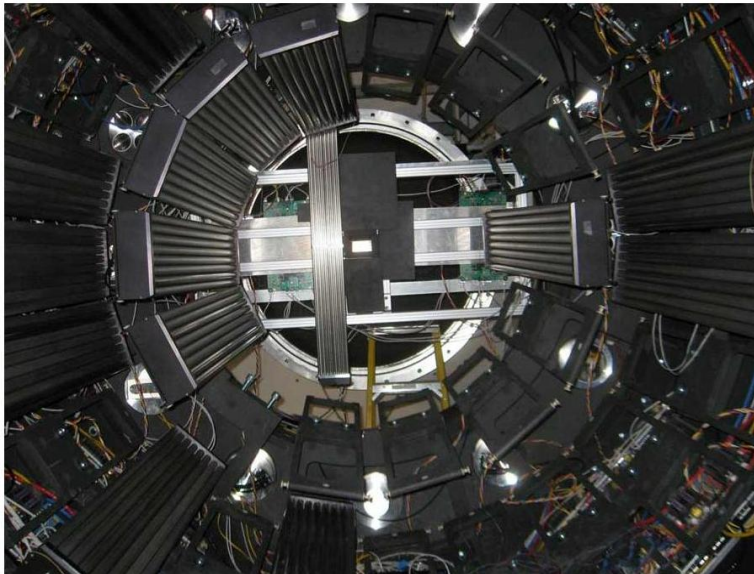
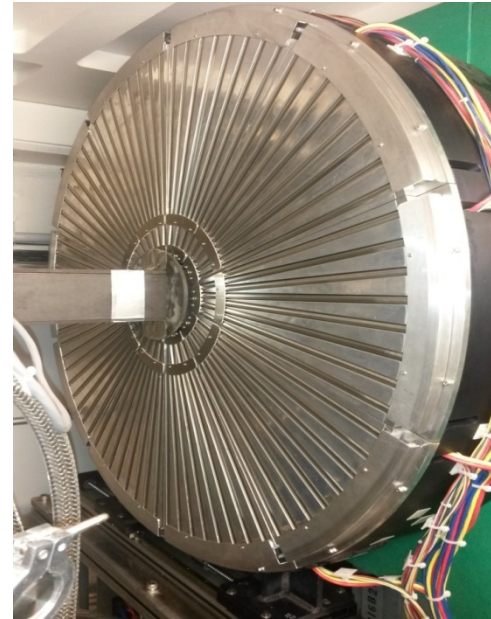
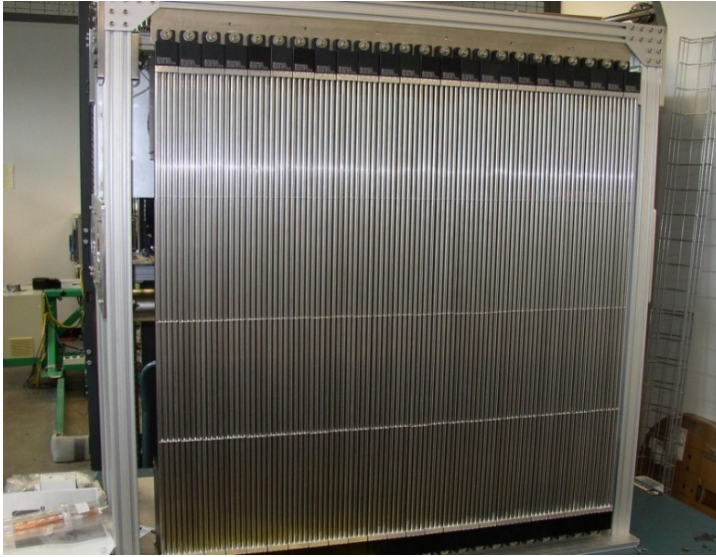

# Multi-wire, areal coverage (common gas space)

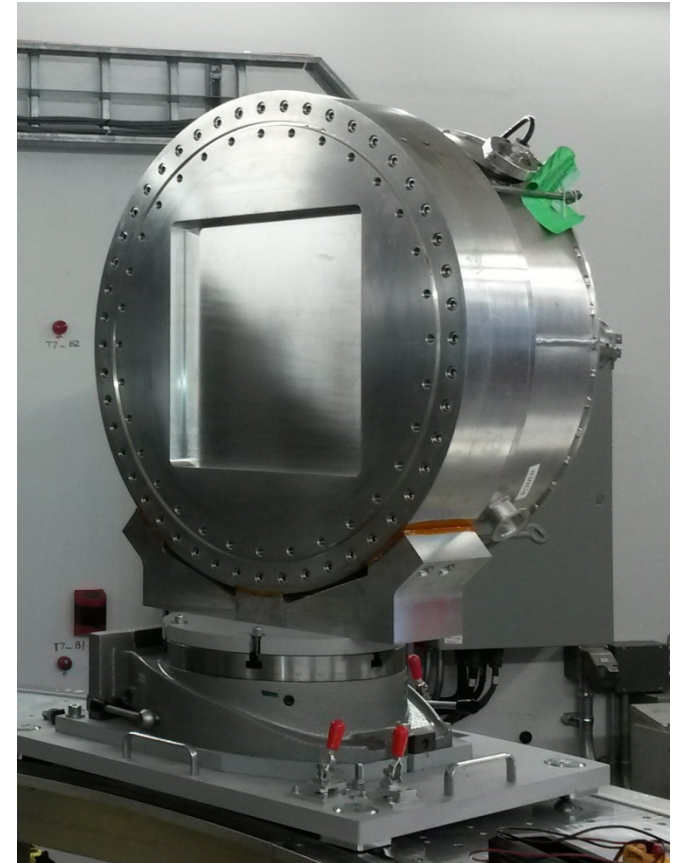
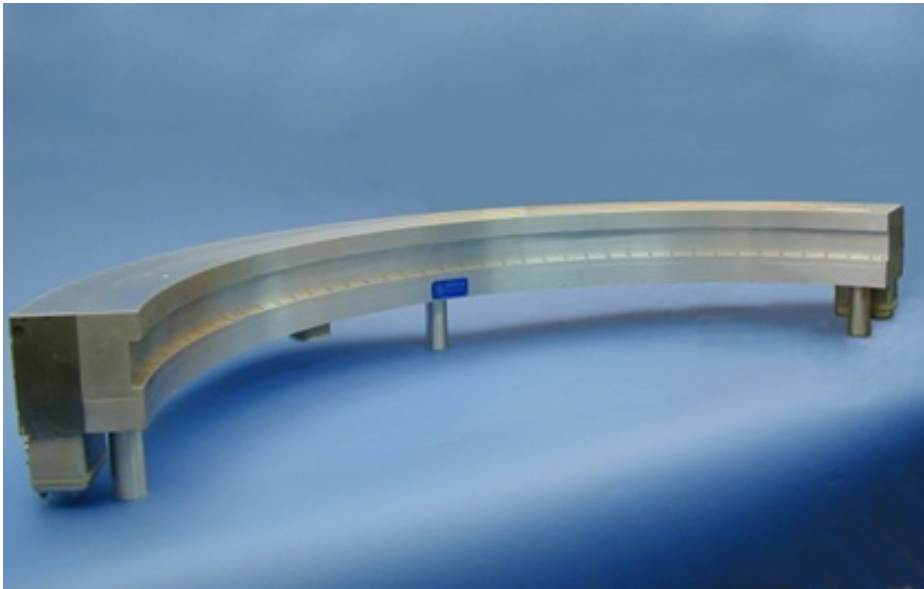
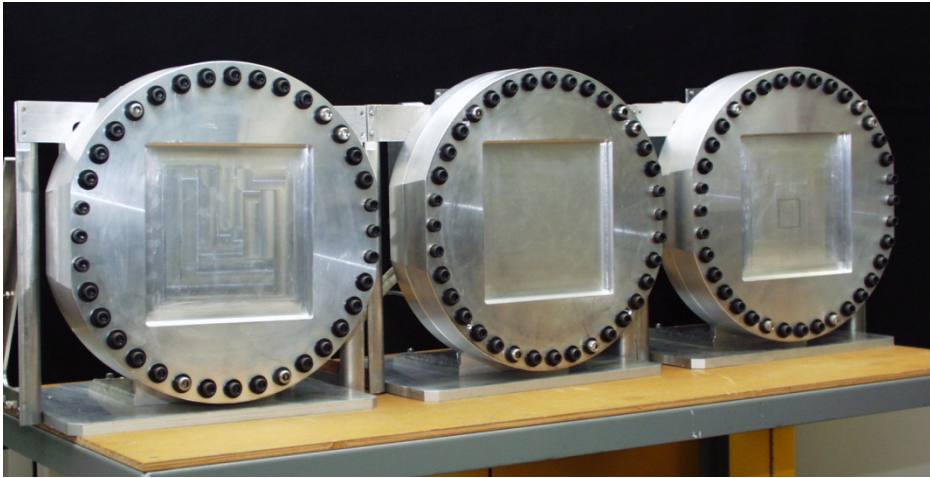

# Brookhaven Multi-Wire Proportional Detector for WAND (HB-2C at HFIR)

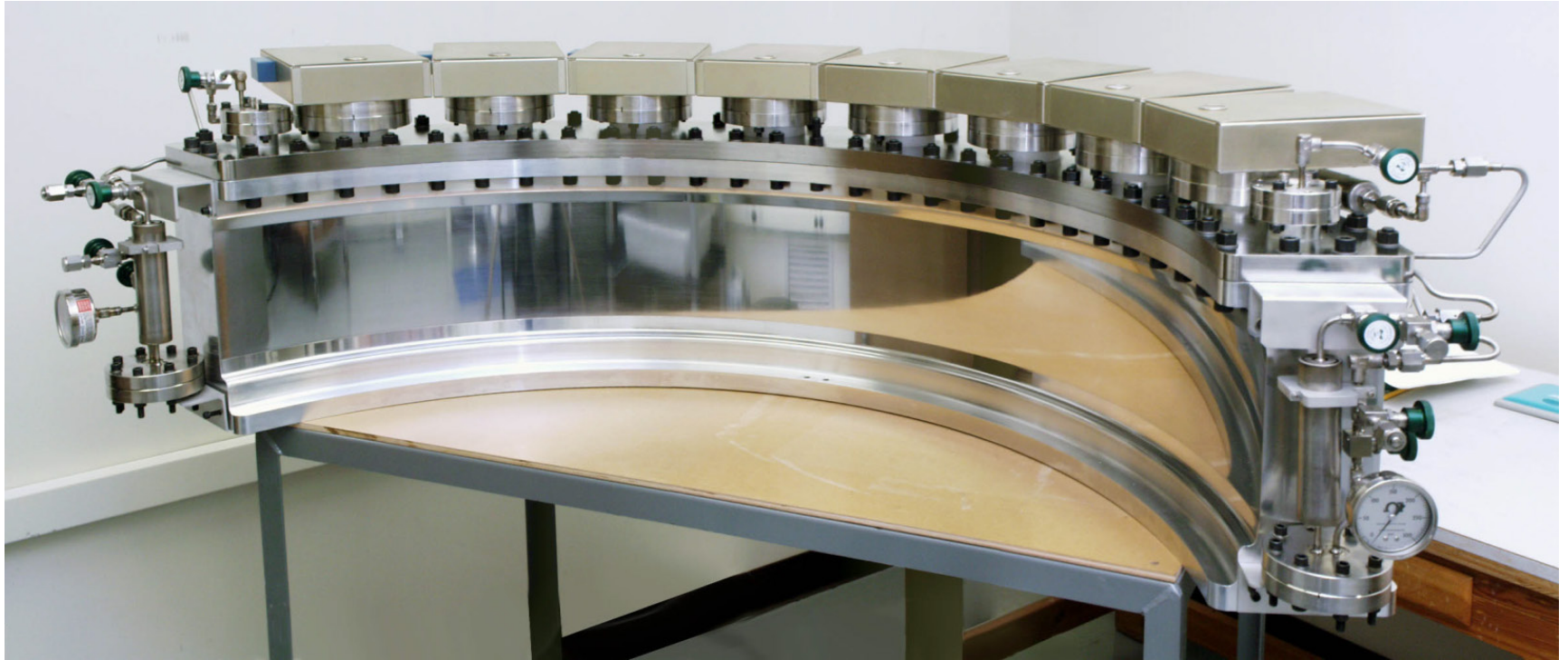

**120° Curved Multi-Wire Proportional Counter (Brookhaven National Lab)  
Currently at PCS Instrument in Los Alamos National Lab, N.M.  
Scheduled for delivery to ORNL end of summer**



# And of course the neutron beam monitors



# Helium-3 Detector Deployment at SNS and HFIR

- **Over 4600 tubes installed at SNS; ~ 600 at HFIR**
  - **Active lengths from 10 cm to 200 cm**
  - **Tube diameters from 0.8 cm to 5 cm**
- **Four multi-wire area detectors (soon to be 5)**
- **Helium-3 pressures from 4 atm to 30 atm**

# Why do we need to 'detect' neutrons ?

Detectors provide us with the information we need to learn about how neutrons interact with our samples

# What do the detectors actually 'detect' ?

What we want to know is intensity (relative to the incident beam) as a function of scattering angle  $2\theta$  and neutron wavelength  $\lambda$

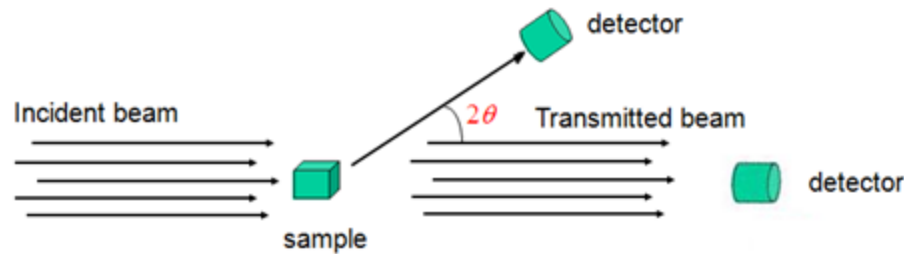

What detectors measure is neutron interaction **location** (and at the SNS, **time**)

$$\text{location } x, y, z \rightarrow \theta \quad \text{time } t \rightarrow \lambda \quad (v = L / t ; p = mv = h/\lambda)$$

The 'effective' size of the detection element is important (spatial and temporal measurement uncertainty), need for different detector types, no 'one size fits all'

# How do we 'detect' neutrons ?

# How do we detect neutrons?

- A neutron must interact with matter in a such a way that it gives some indication of its presence
- With zero net electrical charge, interaction with atomic electrons is not possible (as in X-ray, gamma, electron detectors)

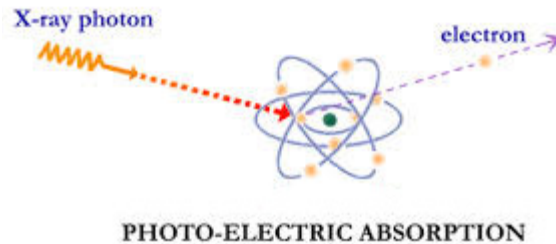

- Instead we must rely on the only interaction available to us – a nuclear reaction with an atomic nucleus

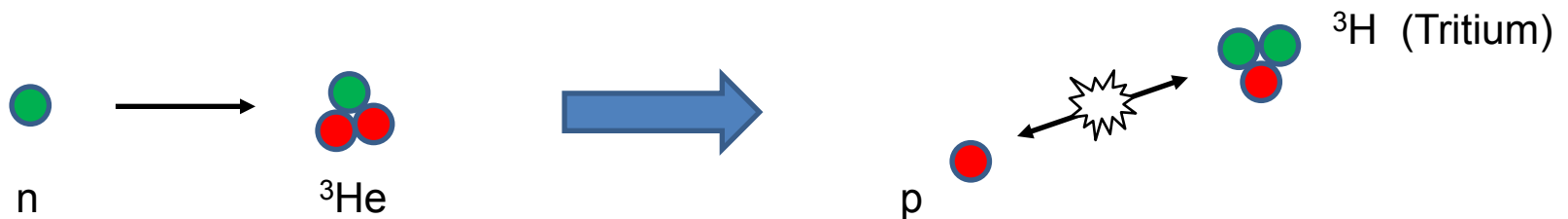

# What materials can we use for neutron detection ?

It turns out there are only a few isotopes for which the neutron has a high probability of interaction with the atomic nucleus, and can be considered candidates for practical thermal neutron detectors

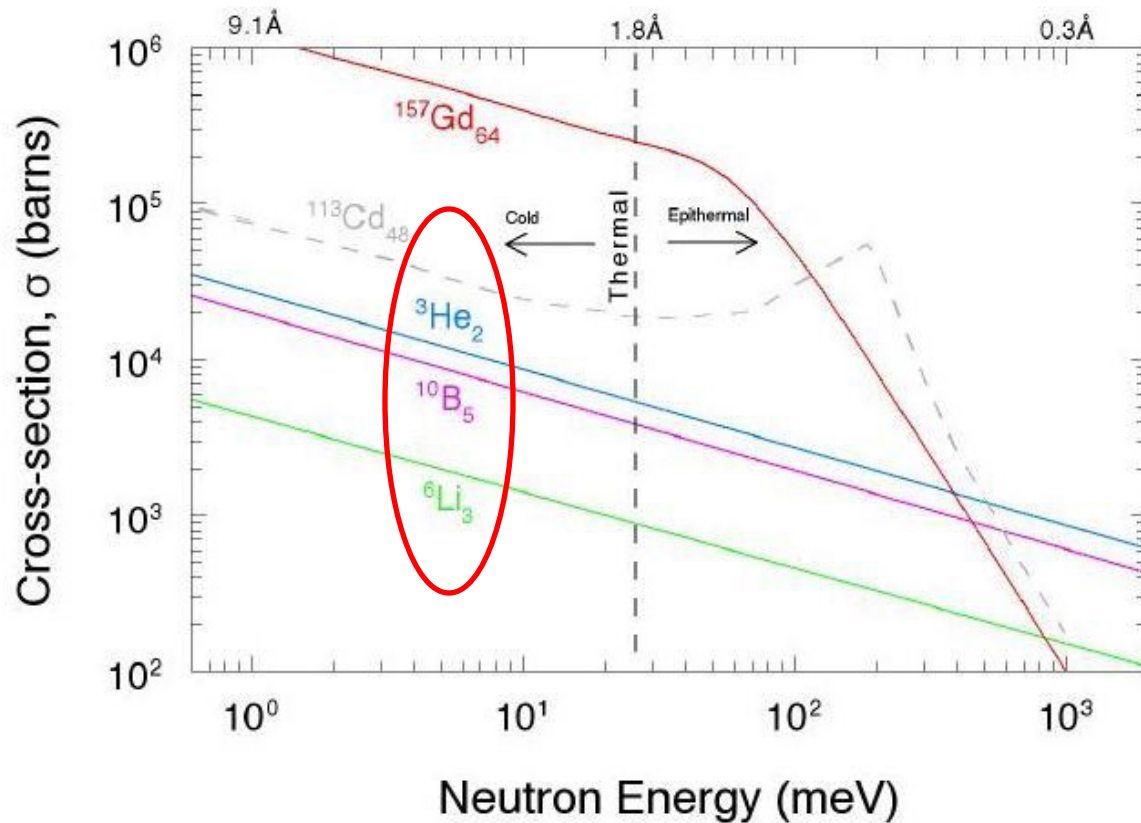

# Relative Cross Sectional Areas (at 1.8 Å)

Cross section has units of area [barns]

It can be thought of as the effective size of the target nucleus



$$1 \text{ barn} = 10^{-28} \text{ m}^2 = 10^{-24} \text{ cm}^2 = 10^2 \text{ fm}^2$$

$$(1 \text{ fm} = 10^{-15} \text{ m})$$

# Important Nuclear Reactions for Neutron Detection

In addition to having a high absorption cross section (probability), the nuclear reaction must produce charged daughter products which can then be detected by more conventional detection technologies

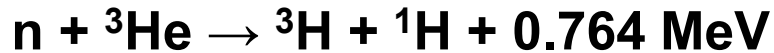

Note the Q values - thermal neutron kinetic energy (10s of meV) cannot be directly measured

# Helium-3

- Natural abundance 0.000137%
- By-product of radioactive decay of tritium (nuclear weapons program)



- U.S. mass production of tritium ceased in the mid 1990's (weapons reduction)
- U.S. demand increased after Sept 11, 2001 (portal monitors, border security)
- In 2008 a critical shortage of helium-3 in the U.S. was realized (supply << demand)
- Efforts to develop alternate detector technologies for large area coverage

Straw Tube detectors, Multi-blade detectors ( ${}^{10}\text{B}$ )

- $\text{BF}_3$  commonly used as neutron gas detector prior to the widespread availability of He-3
  - but  $\text{BF}_3$  is a toxic, corrosive gas (He-3 is inert)
  - nevertheless, some facilities have recently revisited  $\text{BF}_3$  due to the He-3 shortage



# The n-<sup>3</sup>He reaction: $n + {}^3\text{He} \rightarrow {}^3\text{H} + p + 764 \text{ keV}$

Momentum Conservation – trajectories antiparallel

Energy Conservation – KE split inversely proportional to mass (3:1)

- proton kinetic energy = 573 keV
- triton kinetic energy = 191 keV

Reaction products lose energy through interactions with gas atoms (excitation and ionization)

Average energy per pair  $W \sim 30 \text{ eV}$

$\sim 25,000$  electron-ion pairs (4 fC)

$W > IP$  (ionization potential)

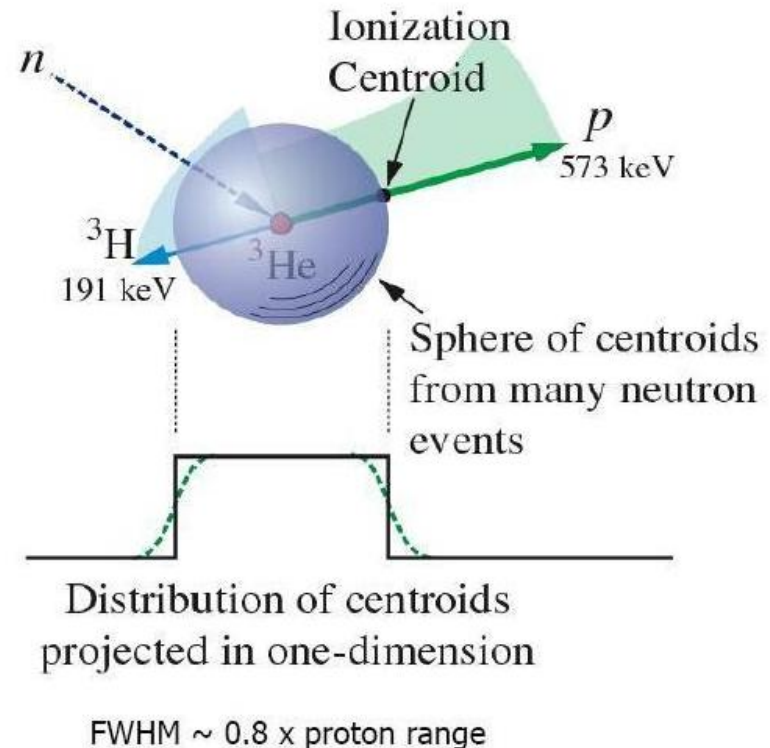

# Proton Range in 1 bar He-3 ~ 5-6 cm

## Range of Secondaries in Gases

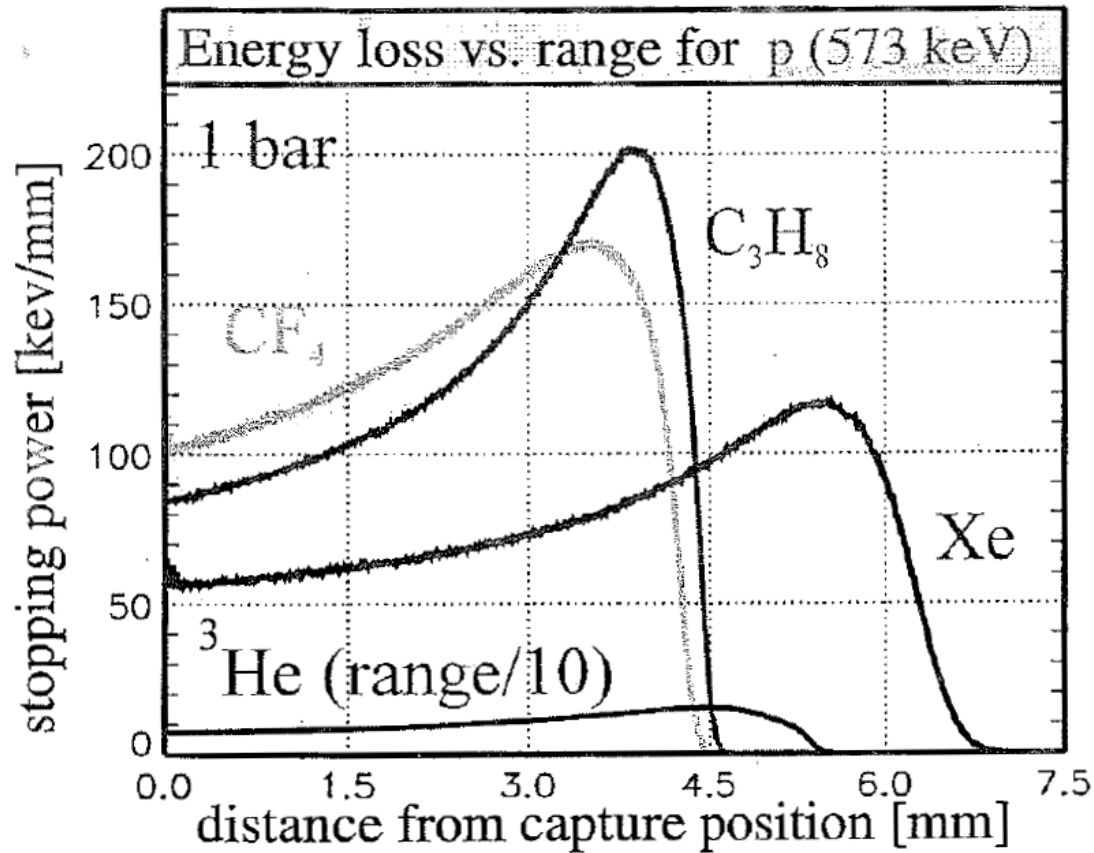

Proton range inversely proportional to pressure – i.e. range  $\approx$  5-6 mm in 10 bar He-3

# Detector Fill Gases: Stopping and Quench

- Stopping gases are added to reduce size of charge cloud
  - Ar, C<sub>3</sub>H<sub>8</sub>, CF<sub>4</sub> in common use
- In addition, polyatomic gases needed for photon quenching
  - UV/Vis photons emitted via excitation interactions, must be absorbed to prevent secondary ionization elsewhere in tube
  - Polyatomic gases de-excite non-radiatively (rot, vib modes)
  - C<sub>3</sub>H<sub>8</sub>, CF<sub>4</sub>, CO<sub>2</sub> in common use
  - stopping gas can also act as the quench gas
- No electronegative gases

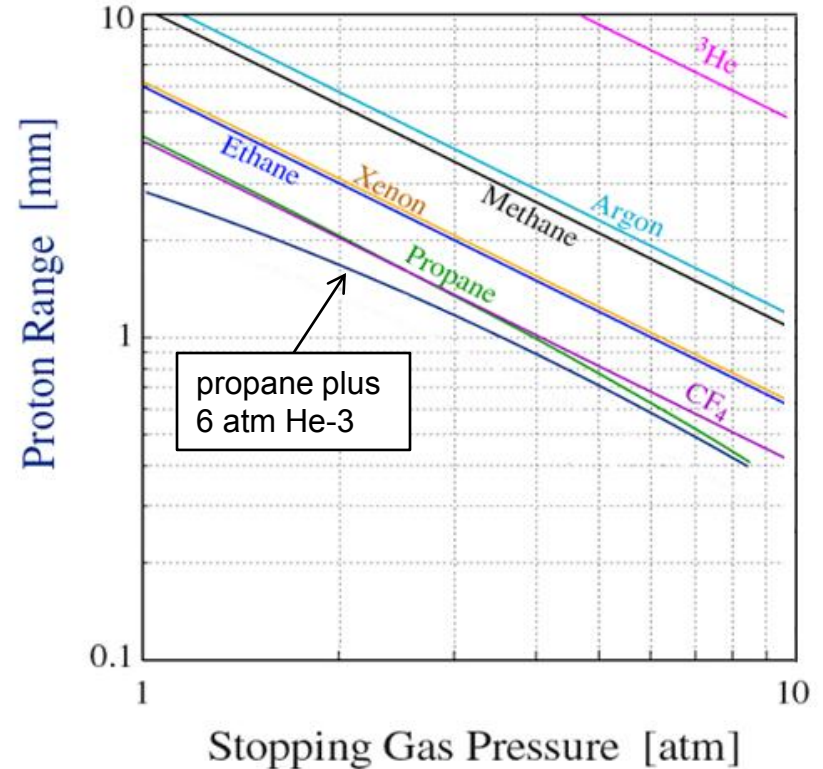

# The Helium-3 Gas Proportional Detector

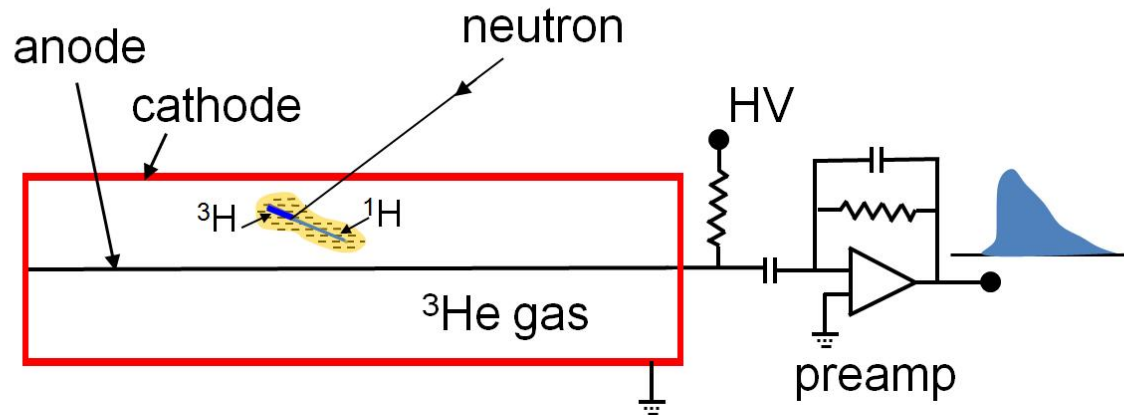

- Positive HV on wire, E field falls off as  $1/r$  (strong near wire)
- Electrons drift in toward wire (anode), ions drift out toward grounded tube wall (cathode), but at velocities  $\sim 1000$  times slower
- Current pulse is measured, proportional to charge collected on wire (Shockley-Ramo theorem)
- 4 fC is impractical, need gas gain to amplify charge signal

# Electric Field and Gas Gain

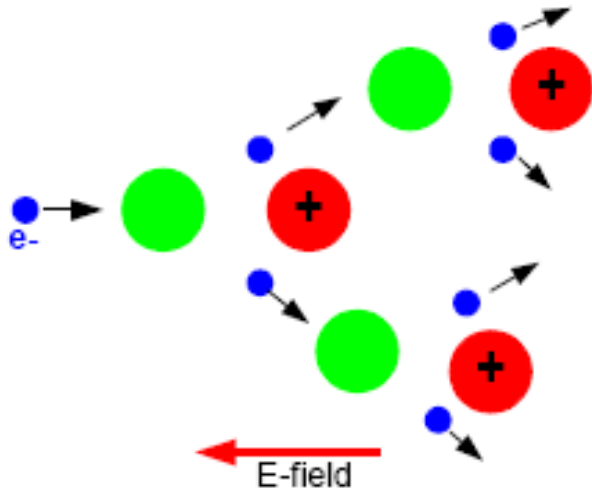

In large E fields, electrons can attain sufficient KE between collisions to ionize a neutral gas atom, producing an electron-ion pair, process creates an avalanche of charge (Townsend discharge)

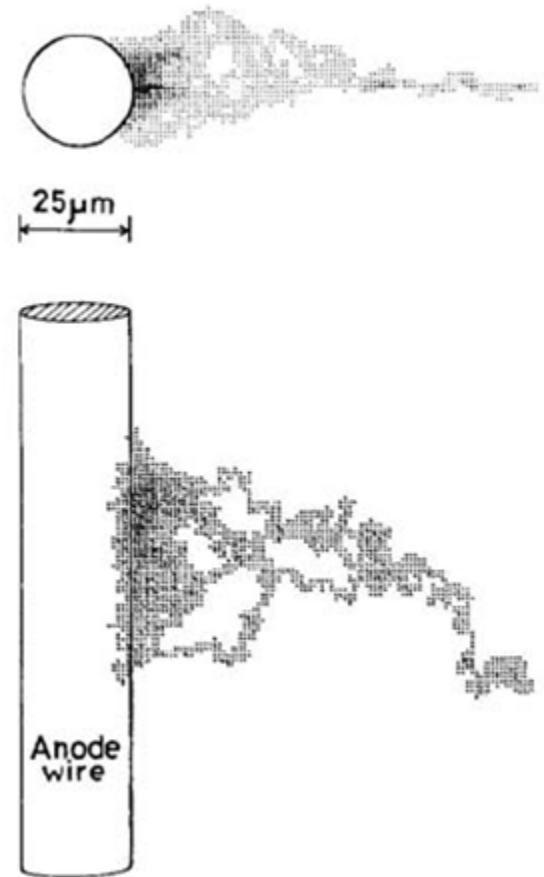

Monte Carlo simulation

Matoba, et al.

IEEE Trans Nuc Sci, Vol. NS-32, No. 1, 1985

# Gas Gain

## Diethorn Model

$$\ln|G| = (V \ln|2|/\Delta V \ln|b/a|) [ \ln\{V/pa \ln|b/a|\} - \ln |K| ]$$

Gain approximately exponential  
with voltage  $G \sim e^V$

Factors include:

- applied voltage  $V$
- anode and cathode radii  $a$  and  $b$
- gas pressure  $p$
- gas specific parameters  $\Delta V$ ,  $E_C/p$   
 $\Delta V$  = potential difference between ionizing collisions  
 $E_C$  = critical electric field for gas multiplication

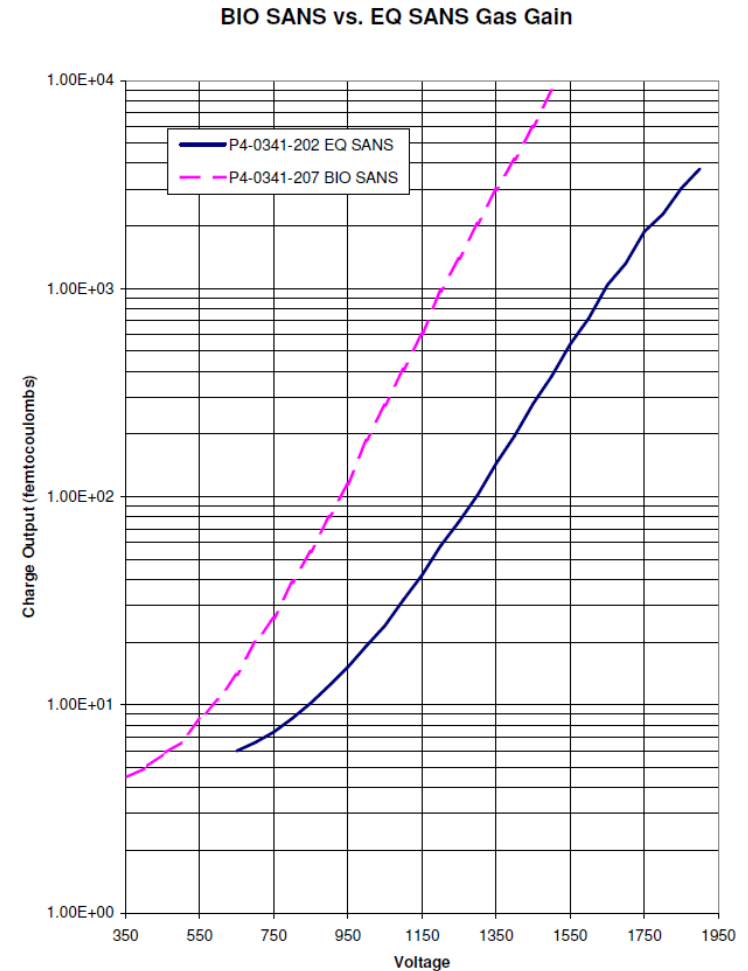

Plot Courtesy of GE Reuter-Stokes

Gas gain of LPSDs typically a few hundred (charge ~ 1 pC)

# Preamplifier signal current in → voltage pulse out

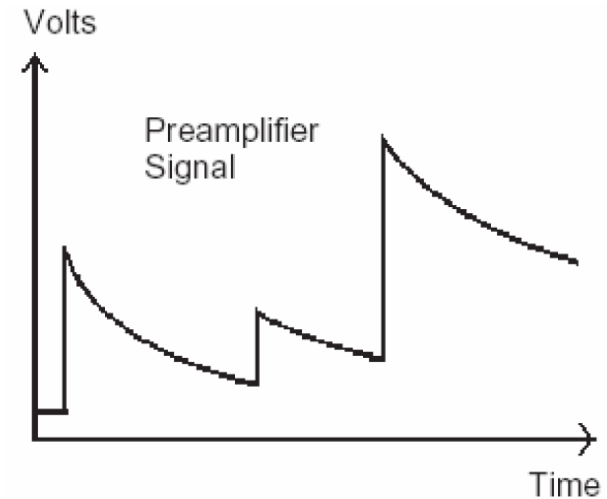
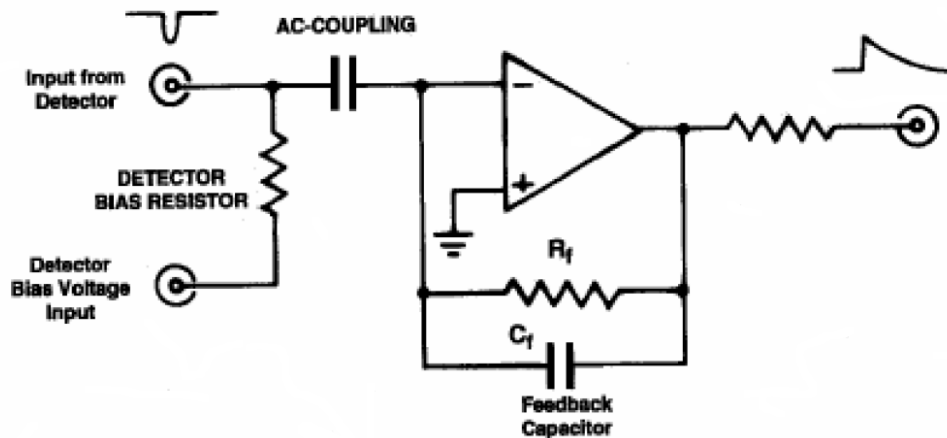
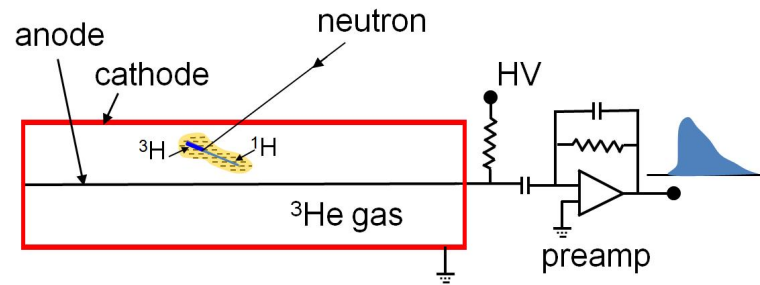

# Differential Pulse Height Distribution and the “Wall” Effect

For interactions which occur near the tube wall, either the proton or the triton can reach the wall before giving up all of its energy to the gas.

The result is less than the full amount of charge collected on the wire.

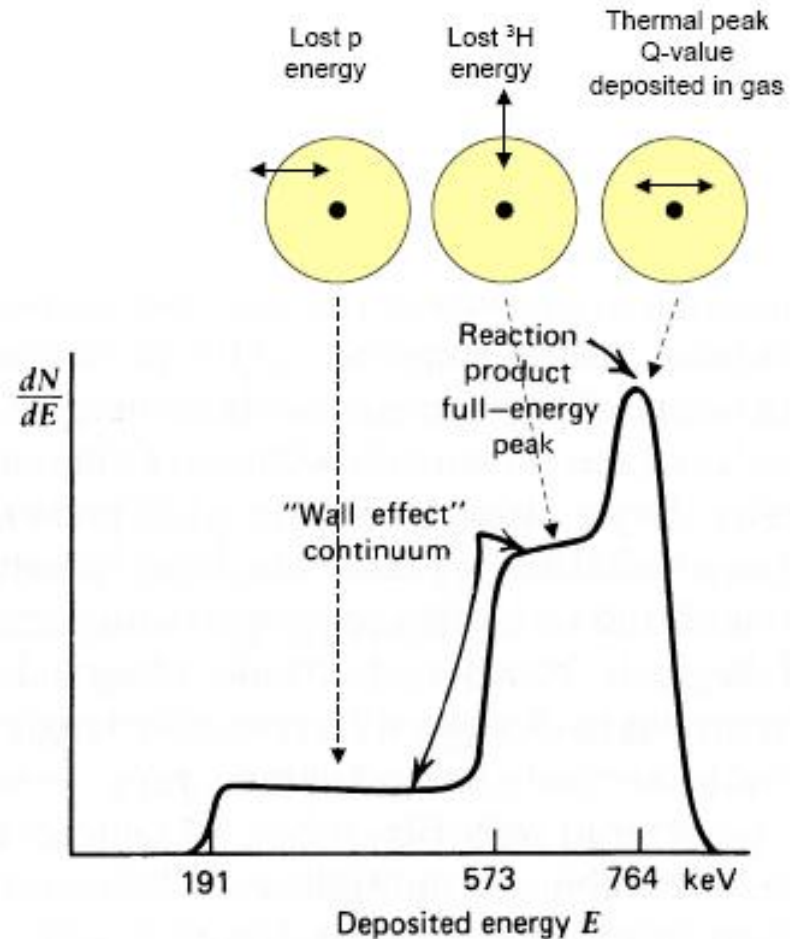

Wall effect depends on tube dimensions and gas pressure



# Discriminator

- Circuit which passes all signal above an (adjustable) threshold voltage, and rejects everything below it
- Some circuits contain both upper and lower discriminators, and pass only what falls between

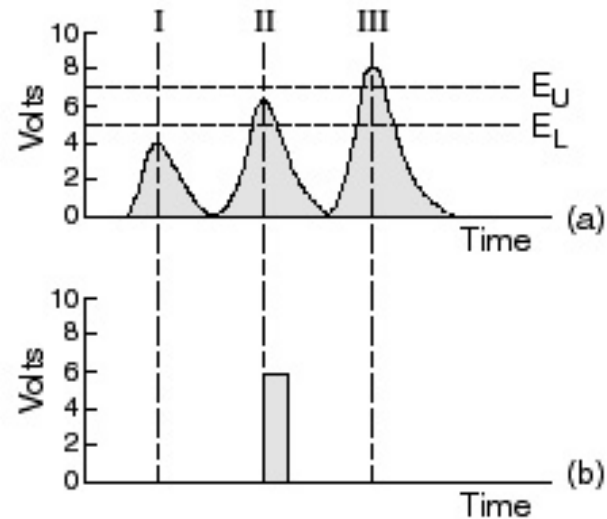
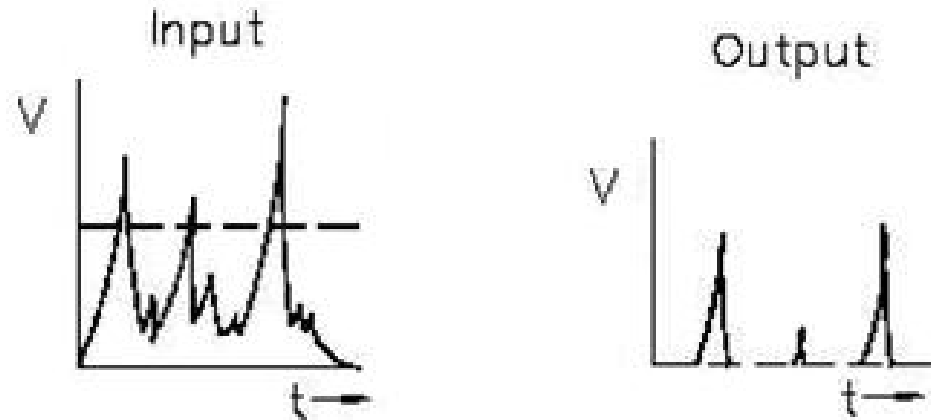

# Wall Effect and Discriminator Setting

- Typically set discriminator just below the low energy neutron shelf to reject counts due to gammas and electronic noise
- Wall effect more pronounced in small diameter (larger surface to volume) or high pressure detectors (short attenuation length)

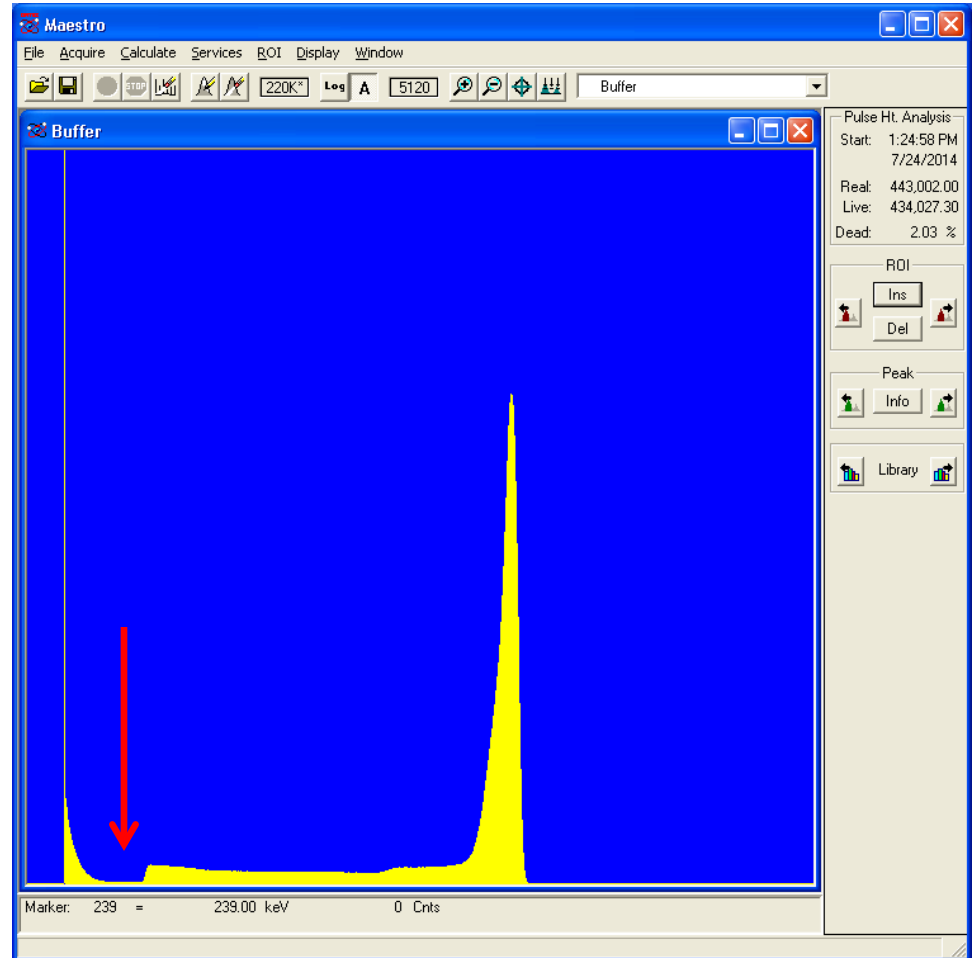

# Single Ended Tubes – Triple Axis and Powder Diffractometer (HFIR)

- Charge sensitive preamplifier plus voltage discriminator
- High voltage applied to anode wire
- All pulses with voltage above discriminator level are counted as neutrons
- No positional information
  - other than event occurred somewhere inside the tube
  - essentially a counter

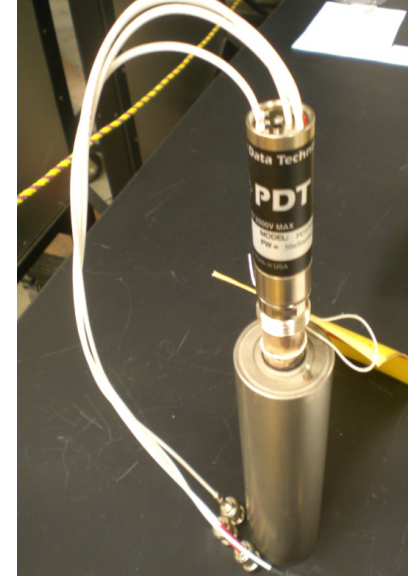

# Linear Position Sensitive Detectors (LPSDs) and Resistive Charge Division

- Modular Assembly “8 packs”
- Resistive anode (few 1000 ohms)
- Anode at HV (1.5 - 2 kV typ)
- Preamplifier at each end of tube
- Current divides according to resistance it sees to preamps
- Current from both preamps is measured, compared
- Mathematical expression  
$$(A - B)/(A + B)$$
determines interaction location

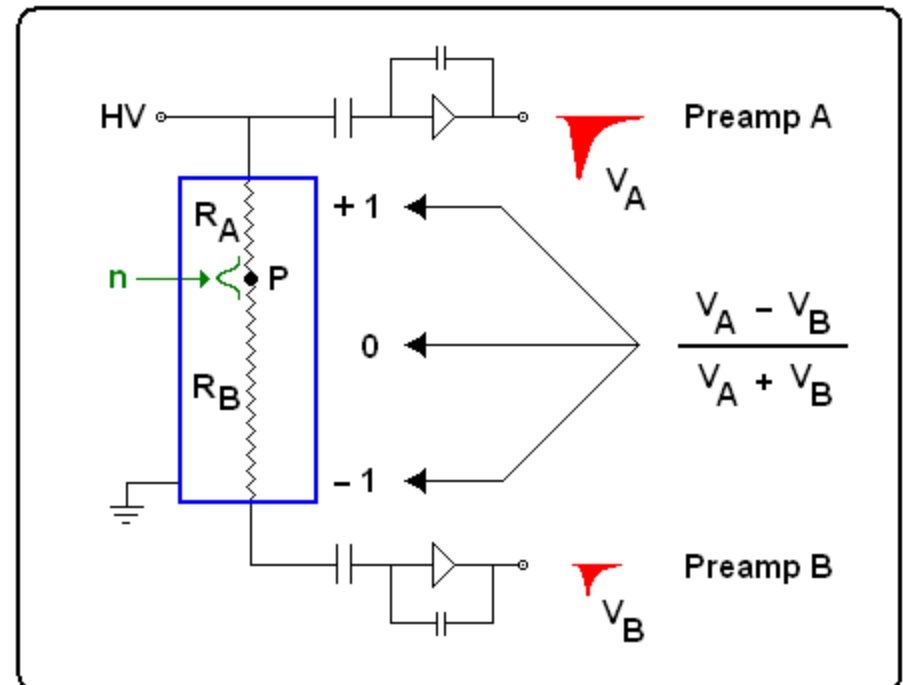
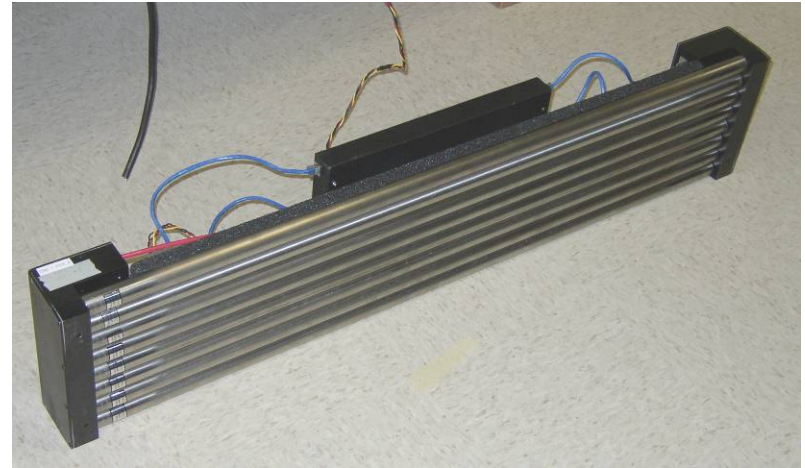

# Wide Range of Pulse Shapes are possible ...

Pulses at right are from interaction near tube end

Pulses below are from interaction near tube center

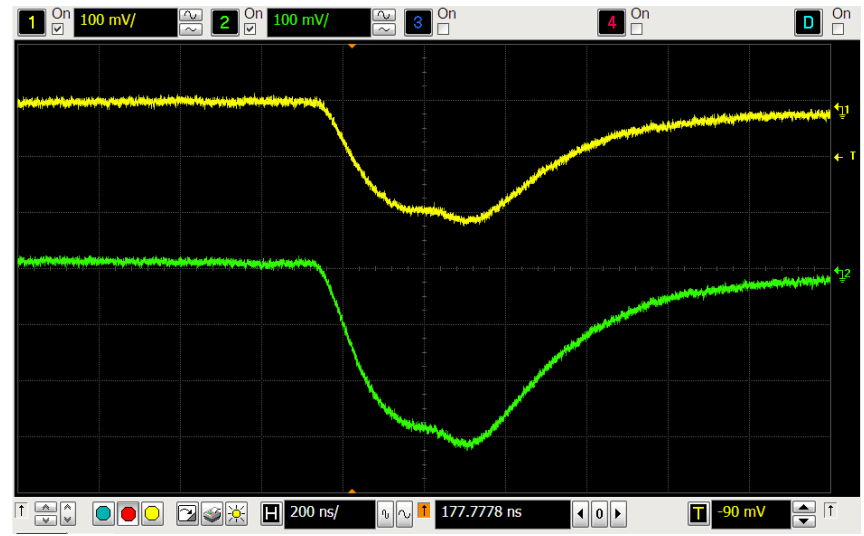
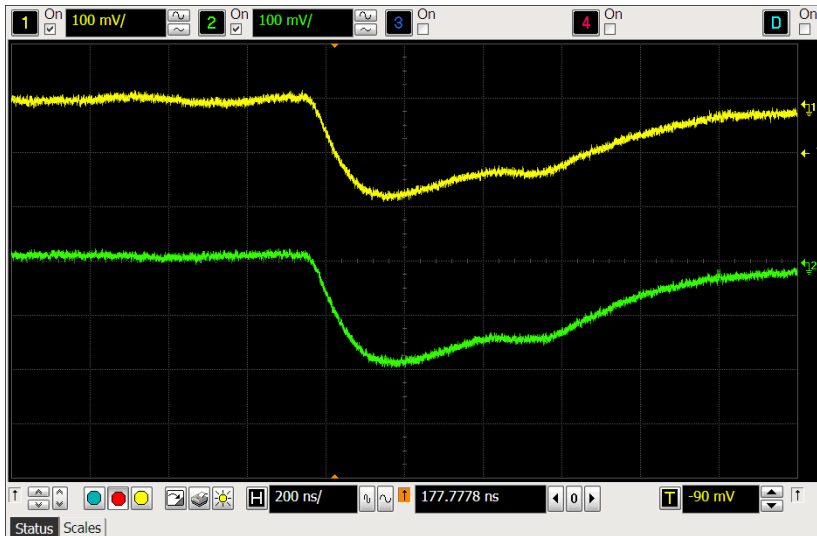
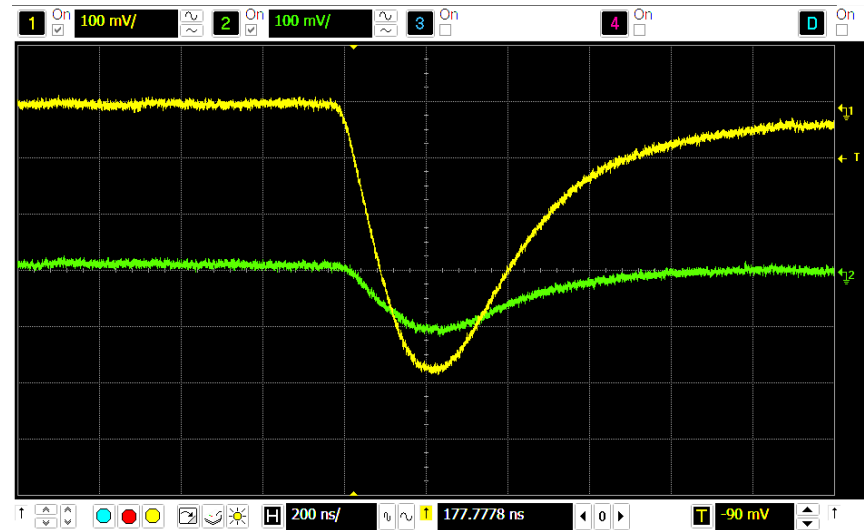

# Neutron detection response along the anode wire

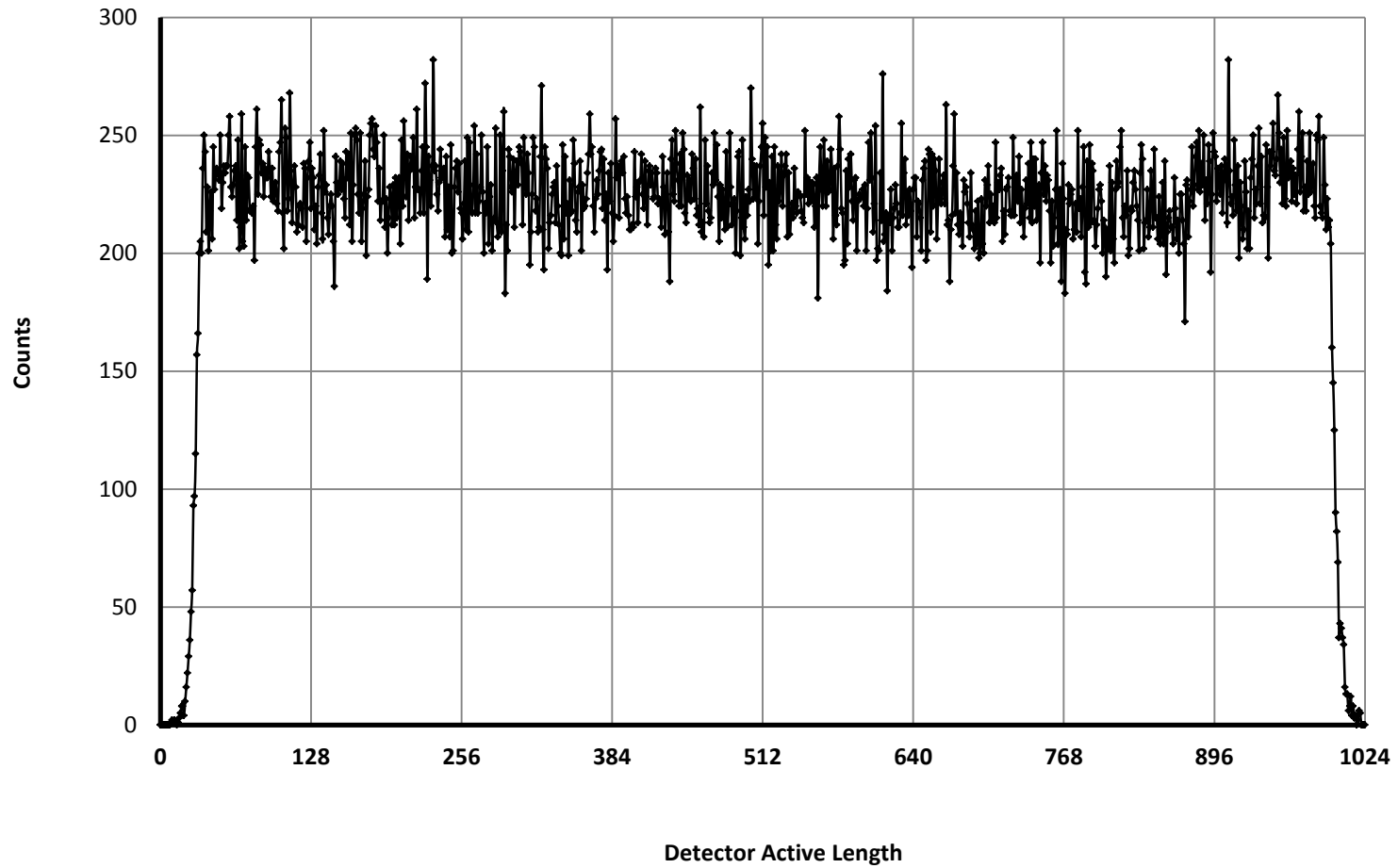

# Area Detectors – BNL MWPC, WAND

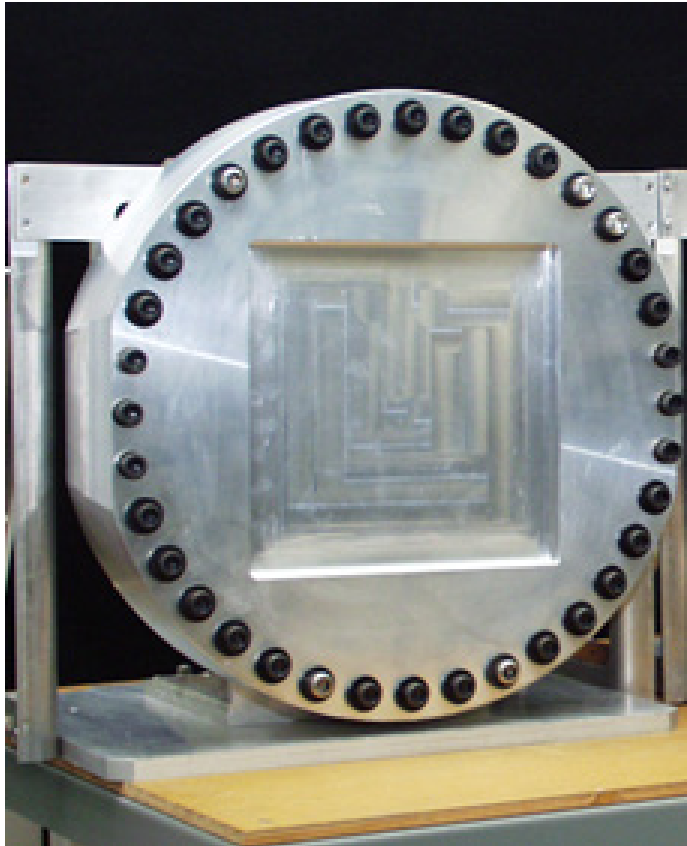

**Multi-Wire Proportional Counter  
(Brookhaven National Laboratory)**

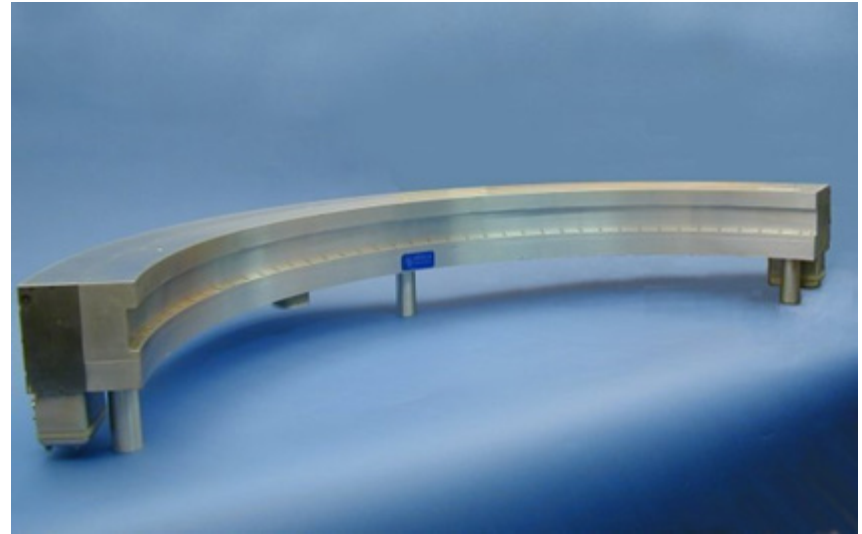

**WAND Detector  
(Ordela, Inc)**

# Multi-Wire Proportional Counters from BNL (SNS Reflectometers)

These detectors date back to the 80's, and still are in service!

- 20 cm x 20 cm active area
- 1.5 cm gas depth ( $^3\text{He} + \text{C}_3\text{H}_8$ )
- X and Y orthogonal cathodes with anode between at + high voltage
- Charge at anode induces signal on cathodes
- Preamps every 7<sup>th</sup> wire (1.1 cm)
- Resistive charge division between each pair of nodes (preamps)
- Low noise, low gas gain ( $\sim 25$ )
- 1.5 mm spatial resolution (x and y)
- Recirculating gas pump and filter
- 4  $\mu\text{s}$  dead time per pulse

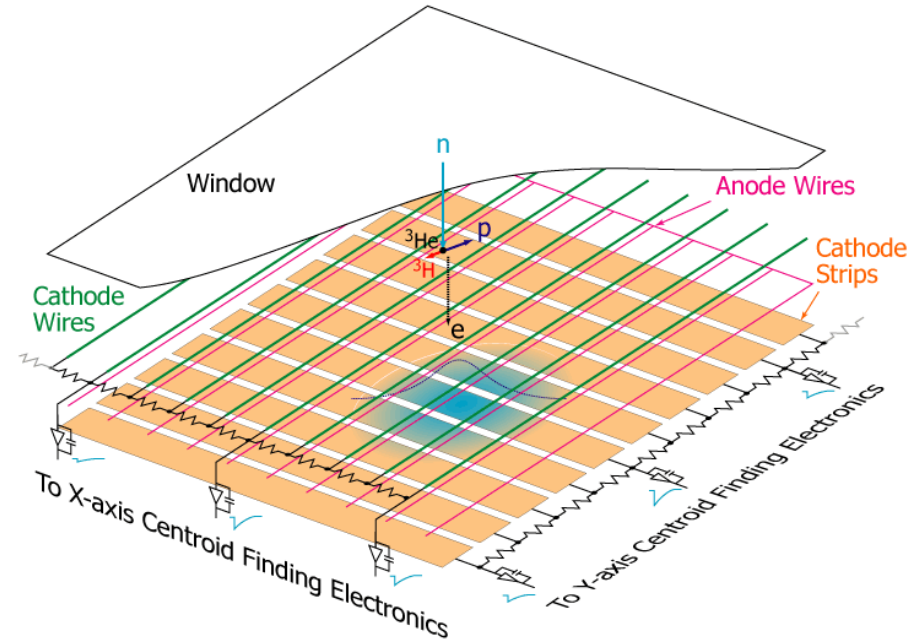

Interpolation based on signals from three wires

$$(C - A) / (A + B + C)$$



# PSDs with Rise Time Encoding (HFIR Neutron Residual Stress Mapping Facility)

- 10 cm long x 5 cm wide active area
- 2 cm active depth
- $^3\text{He} + \text{CF}_4$  at 6.9 atm to give efficiency  $> 65\%$  at  $2 \text{ \AA}$
- Entrance window 2.5 mm 6061 Al
- Anode and Cathode wire planes
- RC or “rise time” encoding (Borkowski-Kopp)
- Two preamps – one at each end of cathode
- Bipolar shaping of signal pulses
- Difference in zero-level crossover times is linearly proportional to neutron position

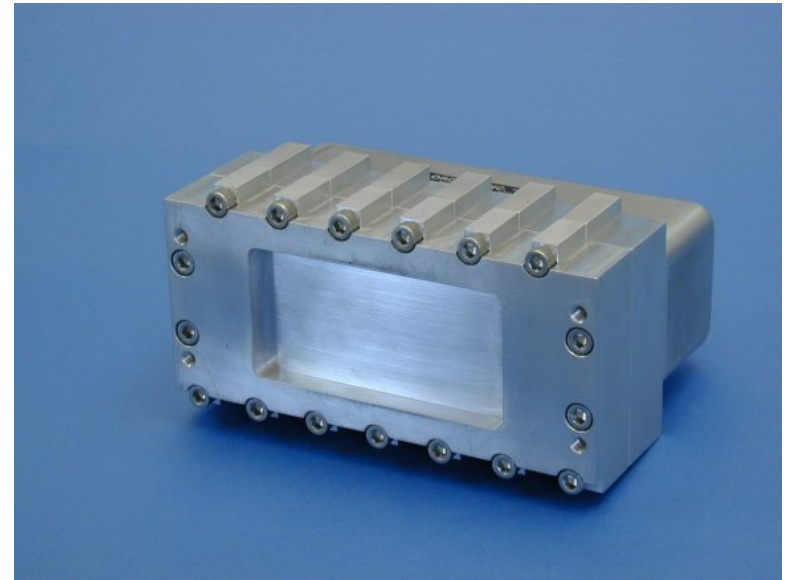

Ordela model 1155N PSD

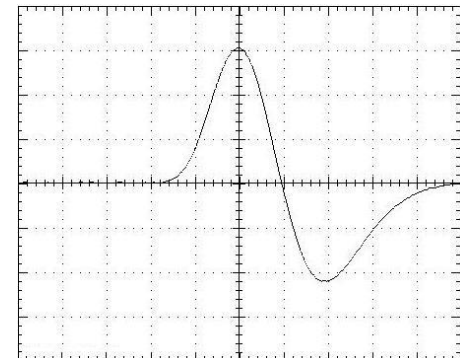

Bipolar Pulse

# Neutron Beam Monitors (Ordela)

- Low gain ( $\sim 7$ ) gas proportional detector
- Two or four anode wires
- Low efficiency ( $10^{-3}$  -  $10^{-5}$  typ)
- $^3\text{He}$  or  $^{14}\text{N}$  conversion gas  
( $^{14}\text{N}$  cross section  $\sim 1.9$  barns)

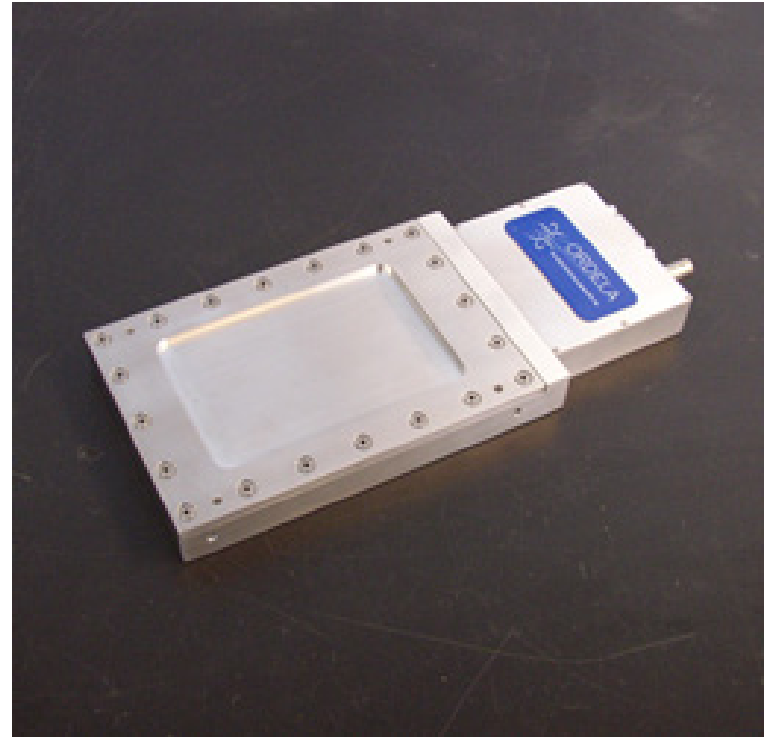

**Note: beam monitor gas is essentially non-attenuating, but the wall thickness is 2 mm 6061 aluminum x 2 = 4 mm per monitor**

**attenuation  $\sim 1\%$  per mm (for  $1\text{\AA}$ )**

# What properties are important in the selection of a neutron detector ?

... some or all depending on the instrument

- Spatial Resolution
- Timing Resolution
- Detection Efficiency
- Count Rate Capability/Dynamic Range
- Gamma Efficiency/Discrimination
- Cost/Areal Coverage
- Long Term Reliability/Maintainability

Resolution is the ability to distinguish between two closely spaced events (in space, time, energy)

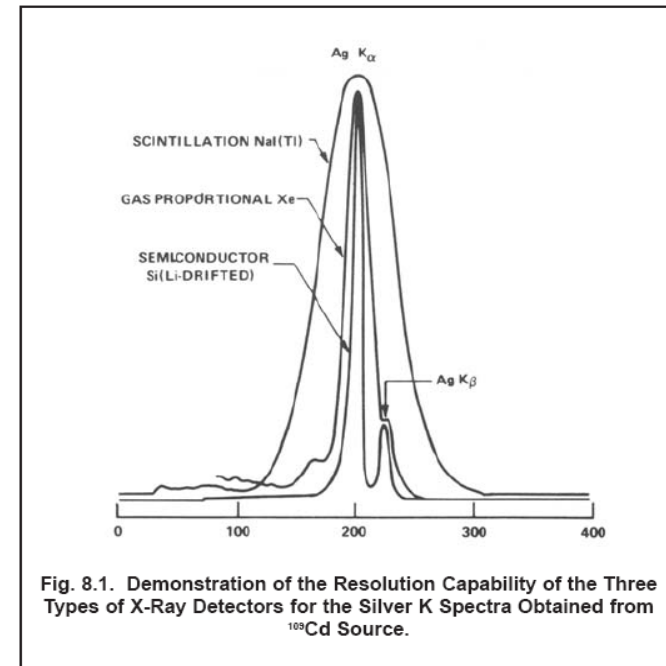

Borrowing an Example from X-Ray Spectroscopy

Courtesy Philip G. Burkhalter and William J. Campbell

U.S. Bureau of Mines, College Park, Maryland

# Slit Mask to Measure Spatial Resolution

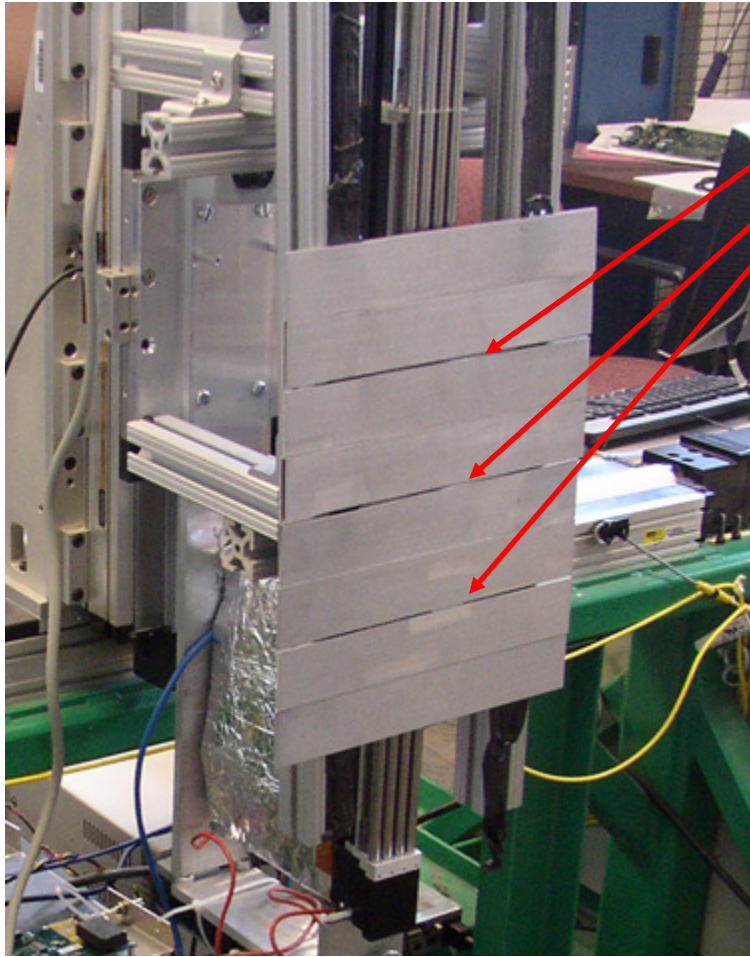

Three Slits in Neutron  
Shielding Mask (BAL)

Detector Response  
Through Three Slit Mask

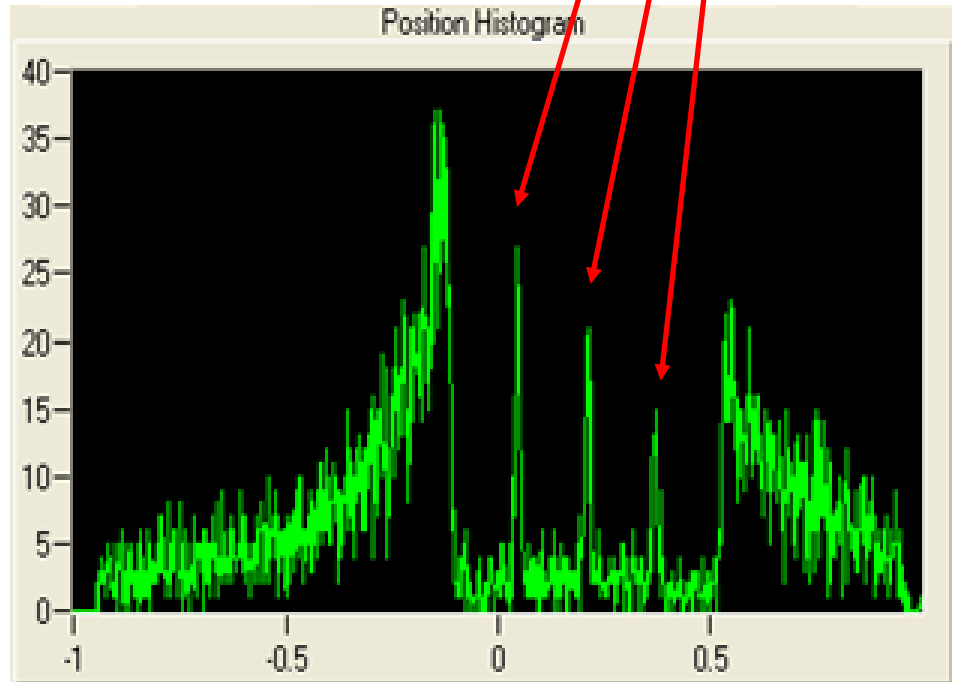

# Timing Resolution and Parallax

Finite detector depth  $d$  contributes to uncertainty in measurement of detection time

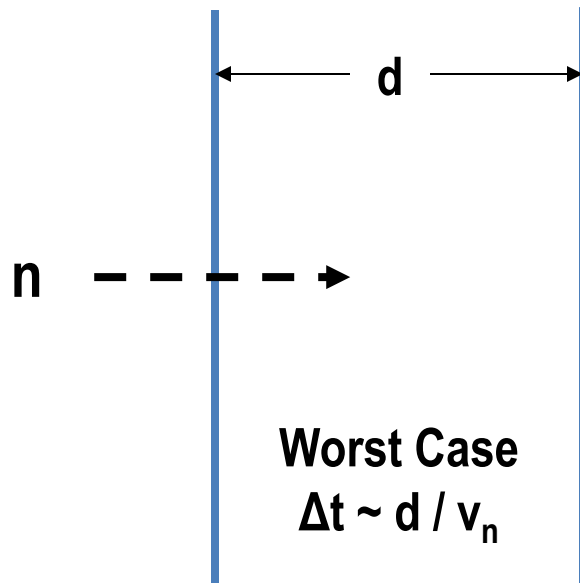

Parallax contributes to spatial (and to lesser extent) temporal uncertainty

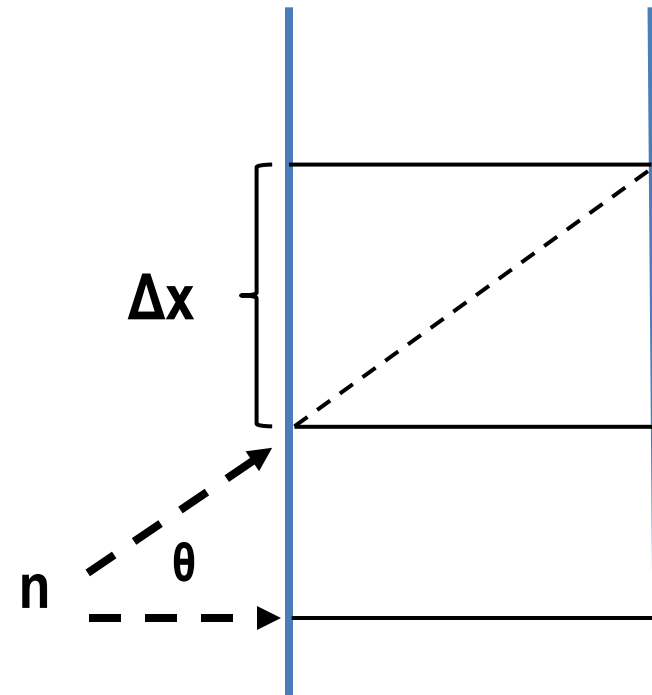

At the SNS, neutron events are time stamped to a precision of 100 ns

But what is the uncertainty in this measurement (for 1.8 Å neutrons,  $v_n \sim 2 \text{ mm}/\mu\text{s}$ )

# Neutron Detection Efficiency

$$\text{efficiency} = 1 - \exp(-n\rho\sigma d)$$

$n$  = number density

$$= 2.7 \times 10^{19} / \text{cm}^3\text{-atm}$$

$\rho$  = gas pressure [atm]

$\sigma(\lambda)$  = cross section [ $\text{cm}^2$ ]

(function of  $\lambda$ )

$d$  = gas depth [cm]

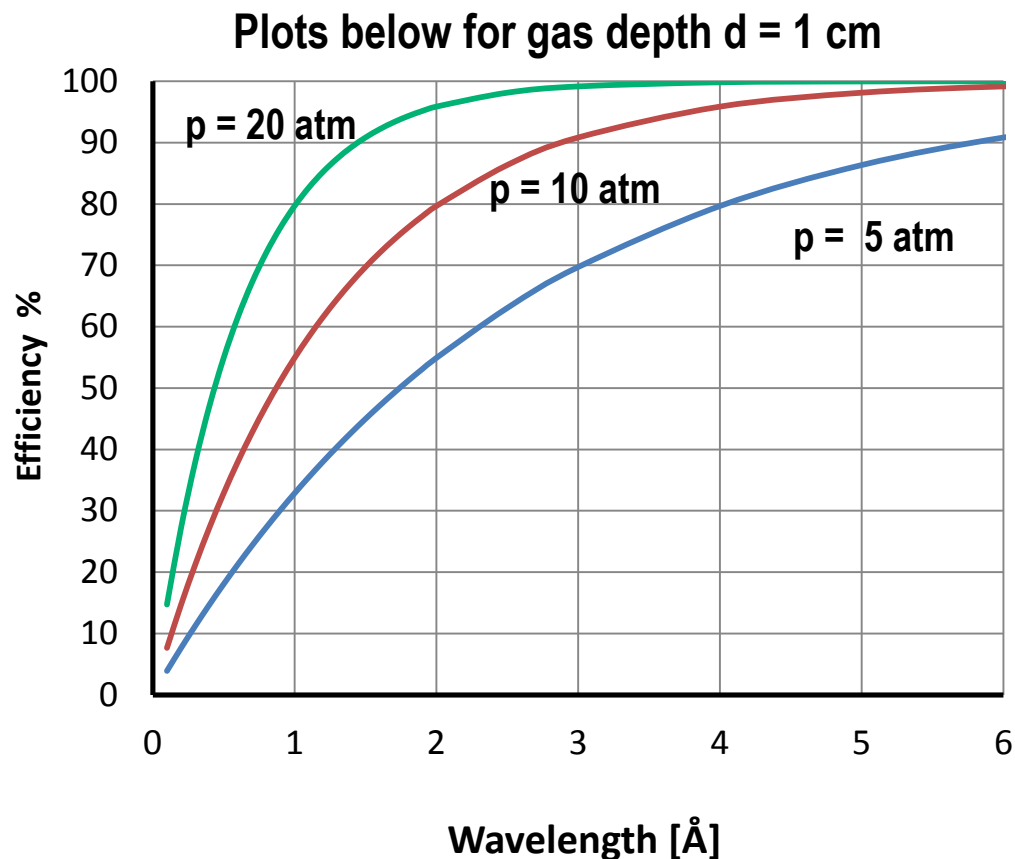

For beam monitors, efficiency  $\approx n\rho\sigma d$

# Gamma Efficiency

- Gamma rays interact with matter primarily through
  - Photoelectric
  - Compton
  - Pair Production ( $>1.02$  MeV)
- Strong dependence on  $Z$
- Combine this with low number density of gases  $\sim 10^{19} - 10^{20}$
- Helium-3 detectors have low gamma efficiencies  
(typically  $< 10^{-6}$ )

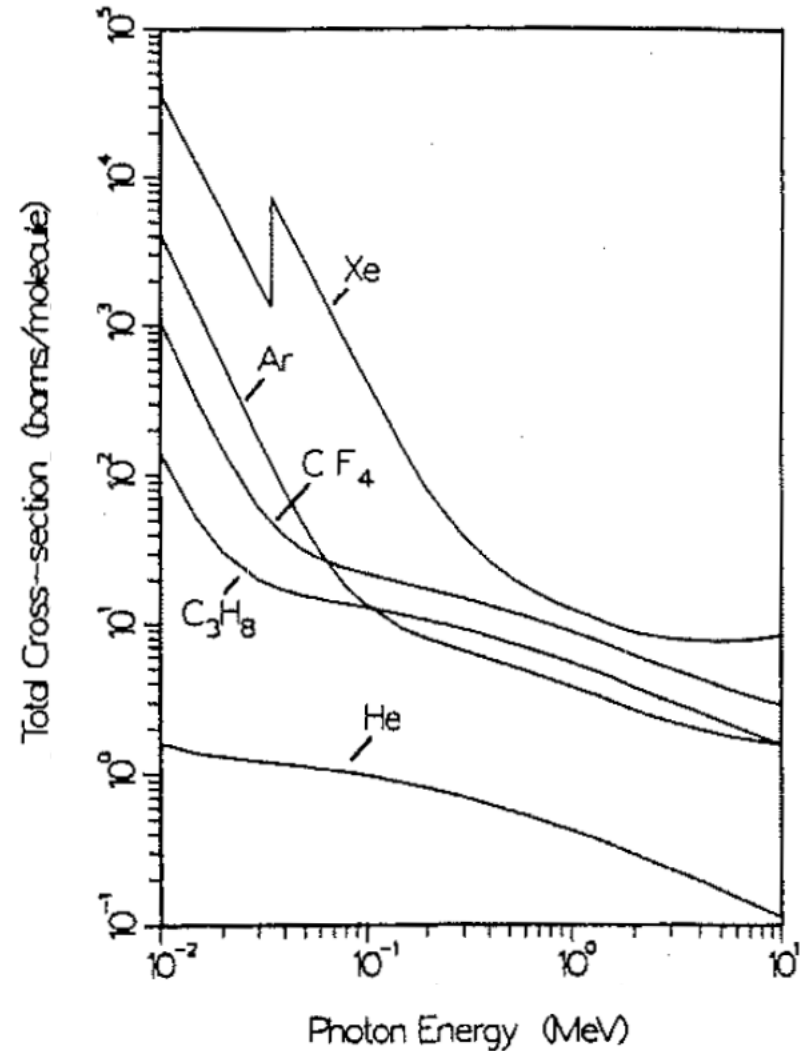

# Lifetime and Aging

- Formation of polymers which deposit on wires
  - hot spots or dead areas
- Polymerization depends on gas purity and composition, also count rate

Question –

- How long will it take to use up the helium-3 in a typical gas detector

Answer –

- Assume  $10^4$  n/s per  $\text{cm}^3$  x  $\pi$  x  $10^7$  s/yr  
 $10 \text{ atm} = 3 \times 10^{20}$  gas atoms per  $\text{cm}^3$   
So, would deplete ~ 1 in 1,000,000  
He-3 atoms in 1000 years !

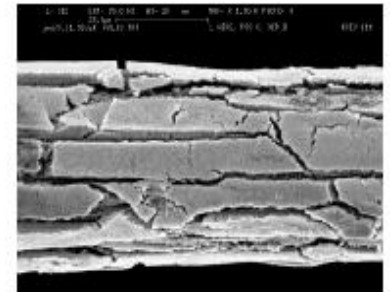
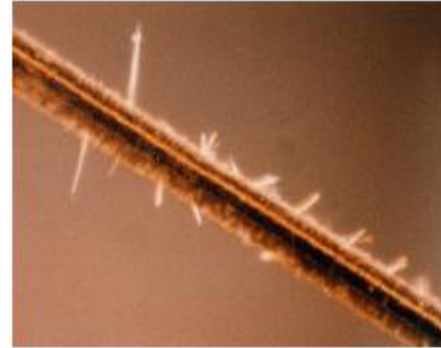

Images courtesy of  
P. Krizan, Ionization Counters

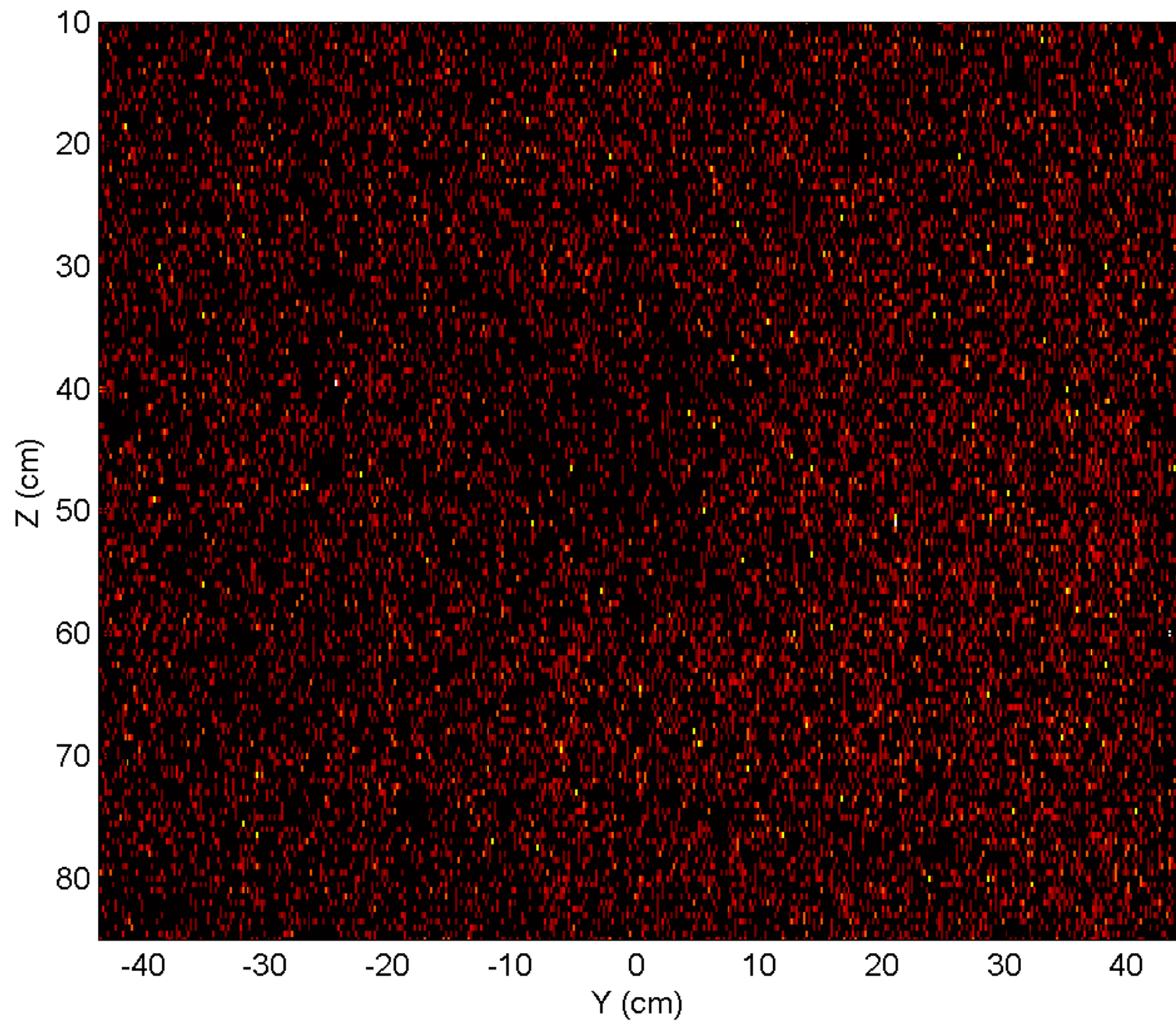

EVENTS = 25343     $\lambda=0.18167 \text{ \AA}$ 

# **Thank You for Your Time and Attention**

## **Acknowledgements:**

**Jack Carpenter**

**Lee Robertson**

**Kent Crawford**

**Ron Cooper**

**Yacouba Diawara**